

# Missouri's River Otter

A Guide to Management  
and Damage Control

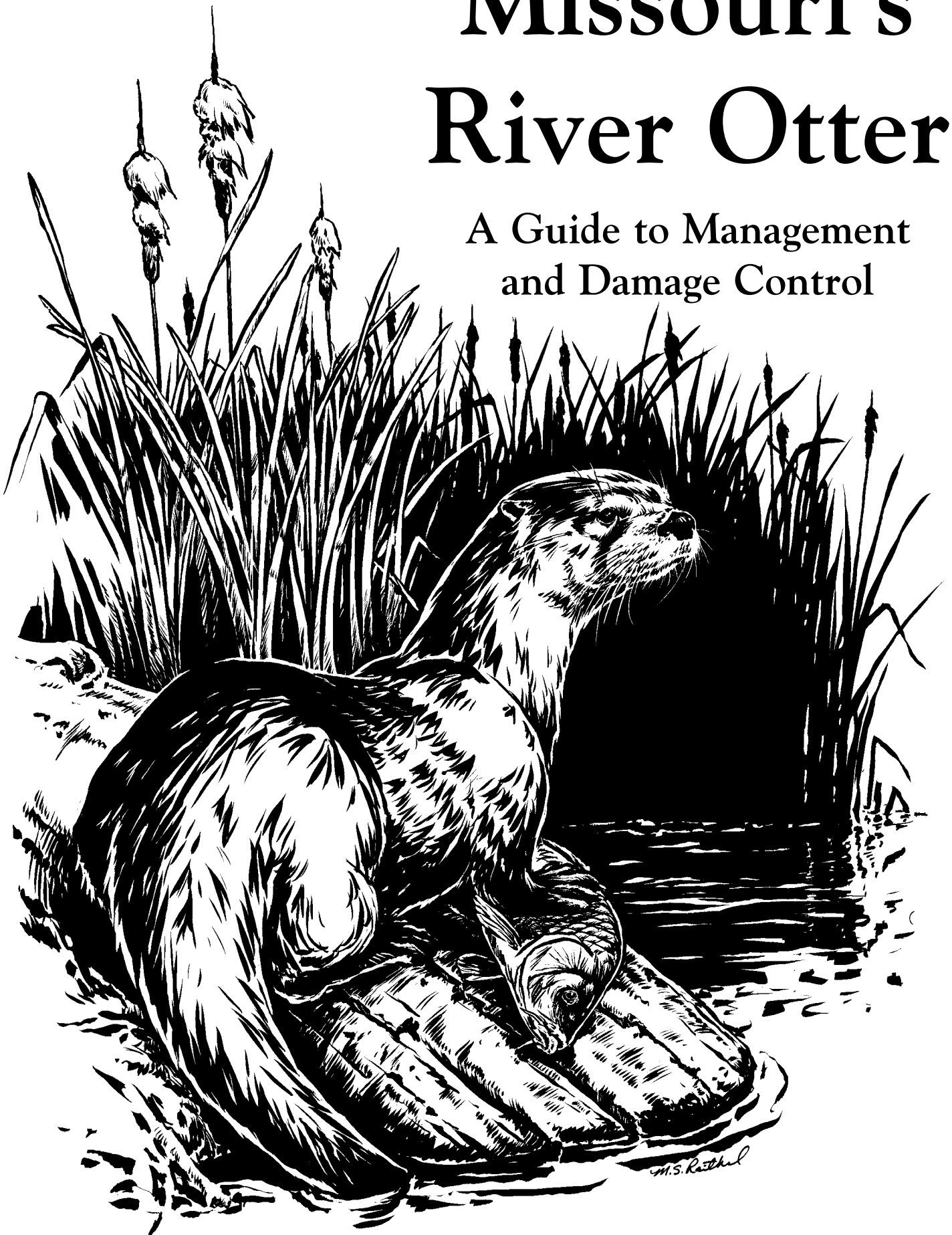

Missouri Department of Conservation

*Equal opportunity to participate in and benefit from programs of the Missouri Department of Conservation is available to all individuals without regard to their race, color, national origin, sex, age or disability. Complaints of discrimination should be sent to the Department of Conservation, P.O. Box 180, Jefferson City, MO 65102, or U.S. Fish & Wildlife Service, 18th and "C" Streets NW, Washington D.C. 20240, Missouri Relay Center –1-800-735-2966 (TDD).*

*Copyright © 2002 by the Conservation Commission of the State of Missouri*

# Contents

**Introduction** ..... 2

**Life History** ..... 3

    Habitat ..... 3

    Reproduction ..... 4

    Social structure ..... 4

    Foods ..... 4

    Habits ..... 4

    Predators ..... 5

    Economic value ..... 5

**Assessing Otter Damage** ..... 6

    Defining objectives ..... 6

    Natural phenomena ..... 6

    Otter sign ..... 7

**Damage Prevention** ..... 8

**Damage Control Techniques** ..... 9

    Shooting ..... 9

    Live trapping ..... 9

    Body-grip traps ..... 11

    Foot-hold traps ..... 11

*In north Missouri streams* ..... 12

*In Ozark streams* ..... 13

    Snares ..... 14

    Set locations ..... 15

*Channel sets* ..... 15

*Crossover sets* ..... 17

*At beaver dens* ..... 18

*At latrine sites* ..... 19

*Pocket sets* ..... 20

**Marketing Pelts** ..... 22

    Fur preparation ..... 22

    How to skin an otter ..... 22

**Conservation Department Regional Offices** ..... 26

**Writers:** Ron McNeely and Kyle Reno

**Editors:** Jim Braithwait, Daryl Damron, Dave Hamilton,  
Tom Hutton, Joan McKee, Scott McWilliams  
and Wendy Sangster

**Illustrator:** Mark Raithel

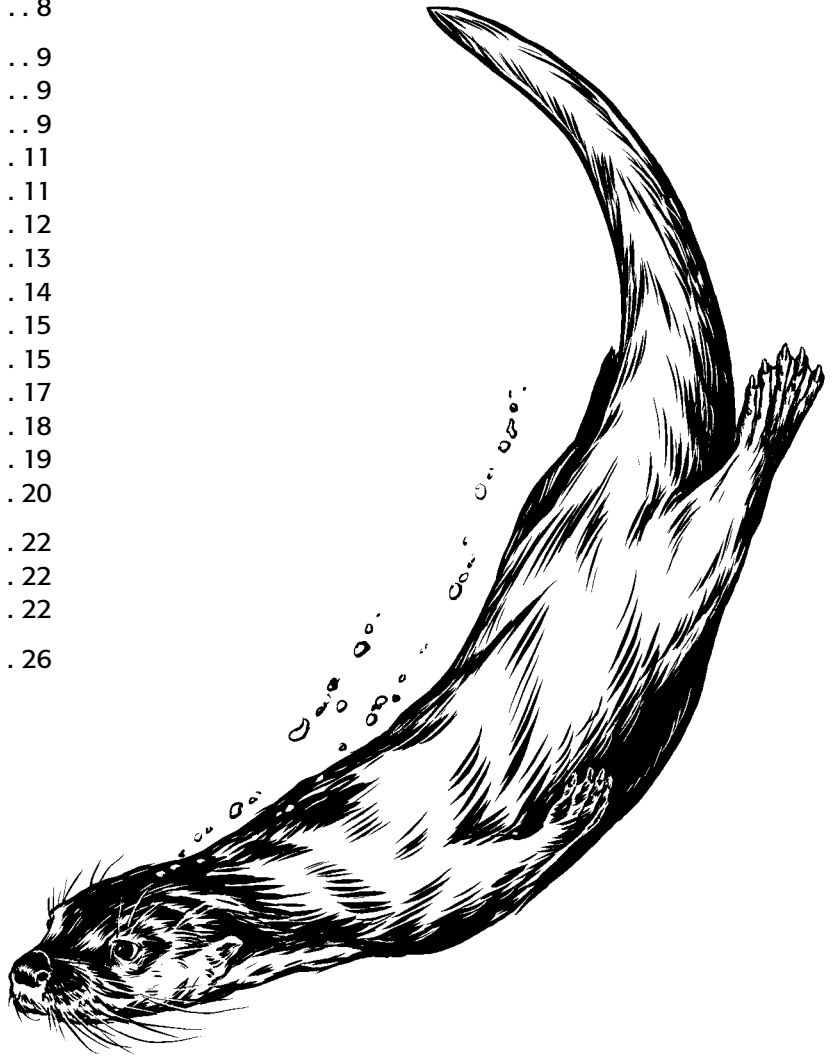
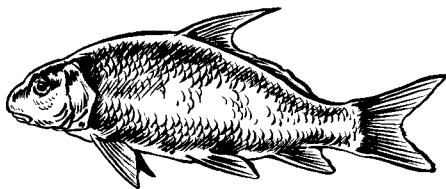

*River otters are once again part of Missouri's natural landscape.*

## Introduction

**R**iver otters were once common to all major streams, wetlands and natural ponds in Missouri. Severe degradation of these features, coupled with unregulated harvest to support the fur market during settlement, almost caused otters to disappear. By 1936, only a few otters remained in southeast Missouri.

In the early 1980s with overwhelming citizen support, the decision was made to restore otter populations to all major streams in the state. Between 1982 and 1992, 845 otters were released in 35 streams with suitable habitat.

From these releases, otters increased their distribution and abundance beyond the highest expectations. By 1996, the otter population had increased sufficiently to support the first trapping season.

Today, otters are at the center of considerable controversy. Opening otter trapping met strong opposition from animal rights groups who filed law suits challenging legalized otter harvest. On the other hand, pond and lake owners and commercial

fish hatcheries regularly report fish depredations by otters whose numbers have grown to nuisance levels in some locations.

Regardless of the controversy, the return of otters spells good news for most Missourians. Many people enjoy viewing otters in the wild, while others are happy just knowing that these furbearers are once again part of our world. The success of otter restoration efforts indicates that water and habitat quality of our rivers, creeks, ponds and wetlands have improved since the 1930s because of successful, large-scale soil and water conservation efforts.

The regulated trapping season provides the only practical method for limiting otter populations in areas where they do substantial damage to fish populations in private lakes and ponds. Smaller bag limits are established in some areas to protect smaller otter populations.

The purpose of this publication is to provide information about:

- life history and biology of otters
- recognizing good otter habitat

### Modern otter harvest by trappers

1996	.....1,054
1997	.....1,149
1998	.....854
1999	.....1,054
2000	.....1,340

*Even with the reinstatement of trapping in 1996, the number of otters continues to increase. By 2001, populations throughout the state were estimated to be between 11,000 and 18,000.*

- interpreting sign and assessing otter damage
- trapping methods for wildlife damage management
- techniques for preparing pelts for personal use or sale.

Should you need further help, a Missouri Department of Conservation wildlife damage biologist can assist you on site with your nuisance otter problems. See page 26 for contact information.

*Otters do eat fish, but their presence in a farm pond does not automatically spell disaster for fish populations. Sometimes otters are mistakenly blamed for problems caused by natural events or other animals. Be sure to identify the cause of the problem before taking action against otters.*



## Life History

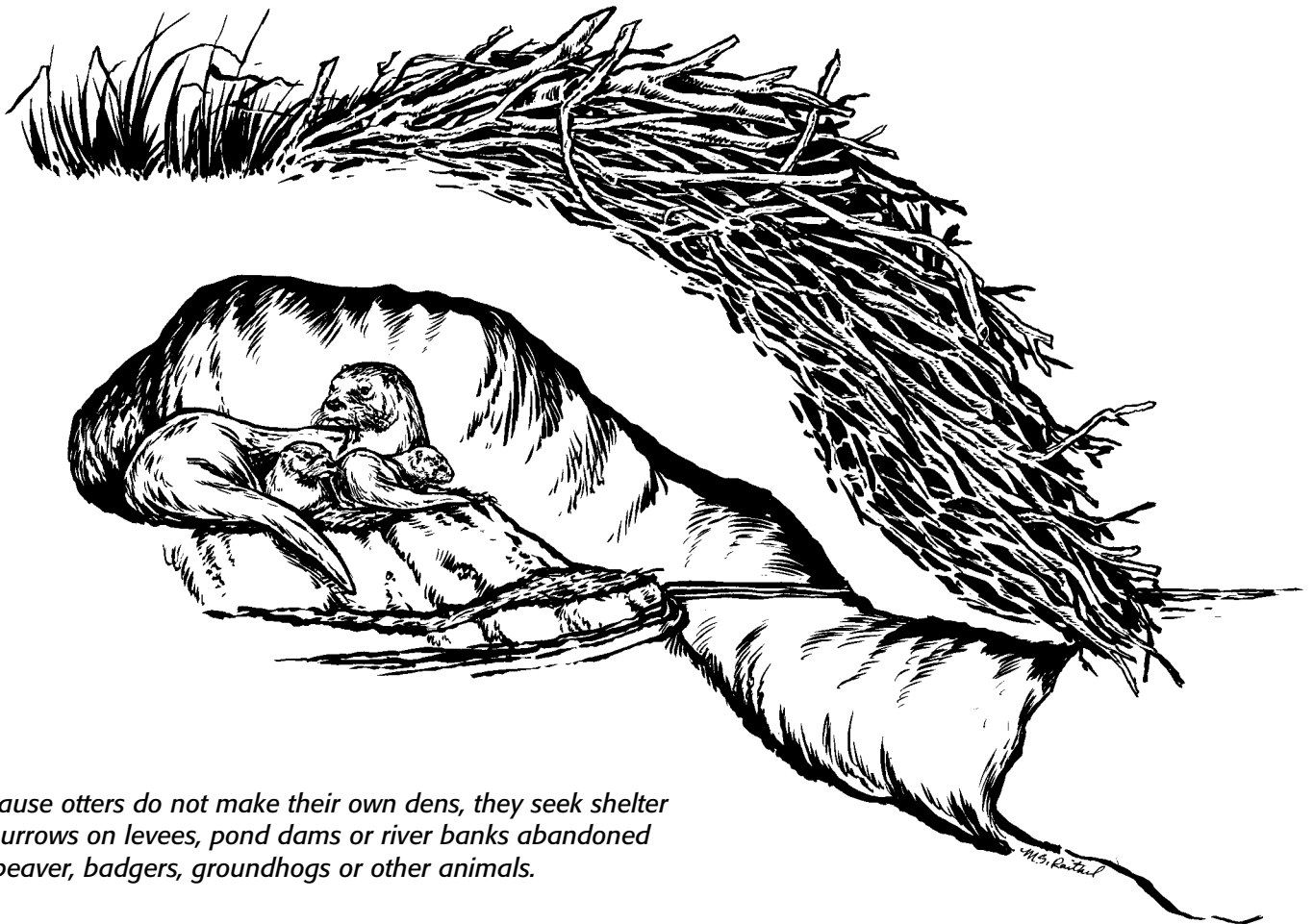

*Because otters do not make their own dens, they seek shelter in burrows on levees, pond dams or river banks abandoned by beaver, badgers, groundhogs or other animals.*

The river otter is Missouri's largest representative of the weasel family. They have broad, flattened heads with prominent whiskers, moderately sized eyes and small ears. The body is almost cylindrical with a stout neck that is nearly the same diameter as the head. Its long, heavy tail is flat on the bottom, thick at the base and tapers from the body towards the tip.

Otters are dark brown in color on the upper parts and may appear black when wet. The belly is pale brown, and the muzzle and throat have a silvery cast. The fur is short, and the underfur is overlain by glossy guard hairs. Juveniles and small adults weigh about 10 pounds, while the largest males

may reach 30 pounds or more.

The river otter is adapted to living most of its life in the water. Some of the most obvious adaptations are the streamlined body, webbed feet and long tapering tail. The ears and nose close when the animal goes underwater, making them water tight. The eyes on top of the head allow the otter to see above water when partially submerged. Its dense fur has more than 10,000 hairs per inch and provides excellent insulation from cold water.

### Habitat

Otters in Missouri are found in streams, ponds and wetland habitat such as oxbows, old river channels,

sloughs and borrow ditches.

Otters are closely associated with beavers, relying on them for dens, as well as for areas to hunt for food. They frequent pools created by beavers to hunt for fish, crayfish and frogs. Because otters do not make their own dens, they typically move into beavers' abandoned dens and lodges. They sometimes seek shelter in muskrat dens or houses. Occasionally otters will use burrows on levees, pond dams or river banks abandoned by badgers, groundhogs or other animals. Bulldozed brush or tree piles adjacent to wetland areas or ponds also are used for denning. Sometimes otters are found living in culverts at fish hatcheries or other impoundments.

## Reproduction

River otters breed in February or March about two weeks after the females give birth to a litter of pups. Like some other members of the weasel family, otters have a delayed-implantation pregnancy. The fertilized eggs do not develop immediately, but remain in the uterine tubes as blastocysts for several months. Two months before the females give birth, the eggs implant in the uterus and embryo developments begins.

Reproductive rates in Missouri have exceeded all previously reported rates for this animal. University of Missouri studies found that 60 percent of 1-year-old females breed, as well as 90 percent of females age two and older. They also are having large litters with three to four pups per litter, which indicates a healthy, growing population.

## Social Structure

Otters are social animals. Females commonly stay with the young until giving birth to a new litter. Siblings may stay together for months after leaving their mother. Males are more solitary than females, but sometimes travel in groups of two or three even during mating season.

## Foods

Otters are carnivores, eating an average of 2.5 pounds of meat every day. Fish and crayfish are their favorite food items. Although fish provide more calories per unit of weight than crayfish, the later are eaten more frequently. Frogs, salamanders, snakes, turtles, muskrats, mussels and other animals are eaten opportunistically.

## Otters eat more crayfish than fish

Analysis of 443 otter stomachs during the 1997-99 trapping seasons revealed the following frequencies of occurrence of food. In 4 percent of the otters studied, the stomachs were empty.

Food type	Percent
Crayfish	61%
Fish	51%
Frogs	17%
Muskrats	3%
Ducks	1%



Otters also prey on migrating waterfowl when they are abundant.

In northern Missouri as water temperatures cool in the fall, crayfish are generally less active and harder to find. During this time, otters start exploring larger streams, lakes and ponds hunting for fish. As spring approaches, otters once again move to wetlands, shallow water sloughs and oxbows, and borrow ditches to feed on crayfish.

In spring-fed Ozark streams, crayfish are available to otters nearly year round and their populations can withstand depredations by otters.

## Habits

Otters resemble seals when swimming underwater. They may swim with their head and back out of water, completely under the water, or in an undulating pattern alternately going above and below the surface of the water. They can swim 1/4 mile under open water or ice and can remain submerged for

three to four minutes.

While very much at home in the water, otters often travel long distances over land from one body of water to another. Otters are especially active during weather changes when frontal boundaries move through.

These short-legged animals usually travel in a bounding gate when on land. On ice and snow, they often make several bounds then slide on their bellies, creating a series of dots and dashes resembling Morse code.

Females stay close to the den when nursing, but will be on the move as soon as the young are old enough to travel. When ice and snow cover streams and ponds, otters hole up in one place for several days. At these times, they may stay in abandoned beaver dens and hunt for fish and frogs under the ice as long as they have a ready food supply.

Otters have regular places where they defecate, called latrines, and others where they roll in the sand,

mud, grass or leaves along stream and lake banks, called wallows. At both of these locations, otters sometimes leave balled up grass and leaves, in which they roll to dry their fur.

At latrines and other sites, scat is used to mark territory. Look for a loose assortment of crayfish remains and fish scales. Regardless of whether they have been eating fish or not, fresh scat will have a distinct fishy smell.

Raccoon scat can easily be confused for otter scat because raccoons tend to leave concentrations of scat at similar places. Raccoons, however, are omnivorous; and their scats will

generally contain the remains of corn, berries and insects.

### **Predators**

Otters in Missouri have few natural enemies. Coyotes, bobcats and large avian predators like eagles, red-tailed hawks or owls occasionally catch a young otter. Adult otters, however, are formidable fighters, quite capable of fending off the largest predators, including domestic dogs.

### **Economic value**

River otters produce one of the most durable furs. Otters were prized by Native Americans and

early European trappers and traders for fashioning durable, warm, water-resistant clothing, as well as for their monetary value in the world markets.

Asian markets have been the primary buyers of American otter pelts in recent history. River otter pelts recently have brought \$60 from rural fur buyers, and as much as \$90 at Canadian fur auctions. Compared to mink, raccoon, muskrat and other furbearer pelts, otters are the most valuable.

In spite of the higher prices for their fur, few people in Missouri trap specifically for otters. In fact, only about 25 percent of licensed trappers catch otters each year.

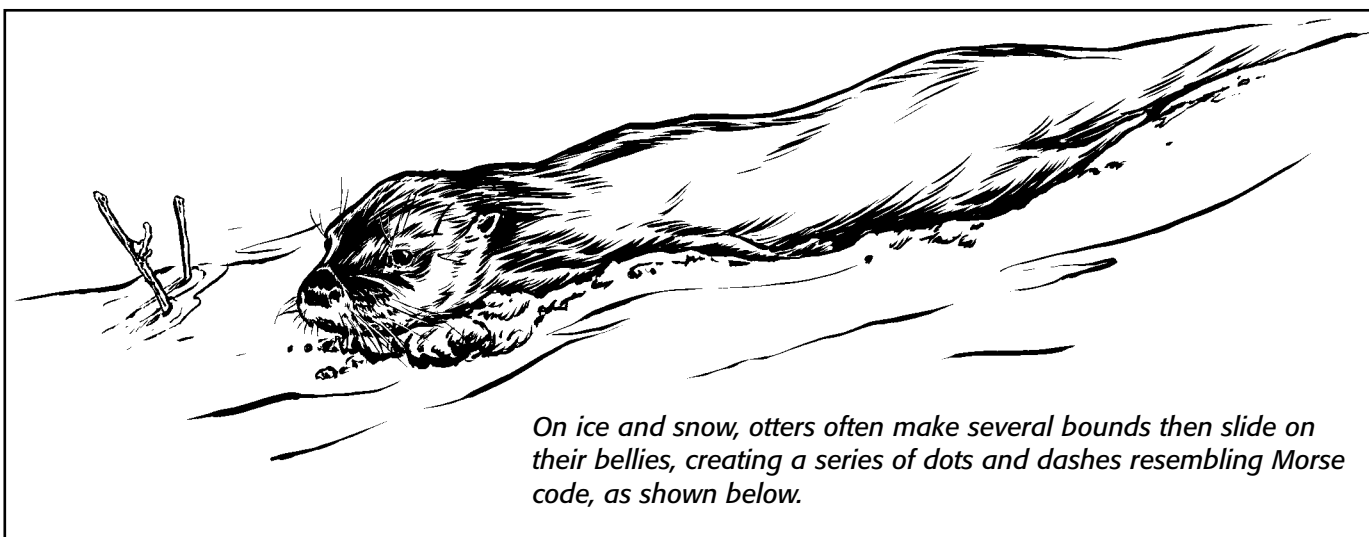

*On ice and snow, otters often make several bounds then slide on their bellies, creating a series of dots and dashes resembling Morse code, as shown below.*

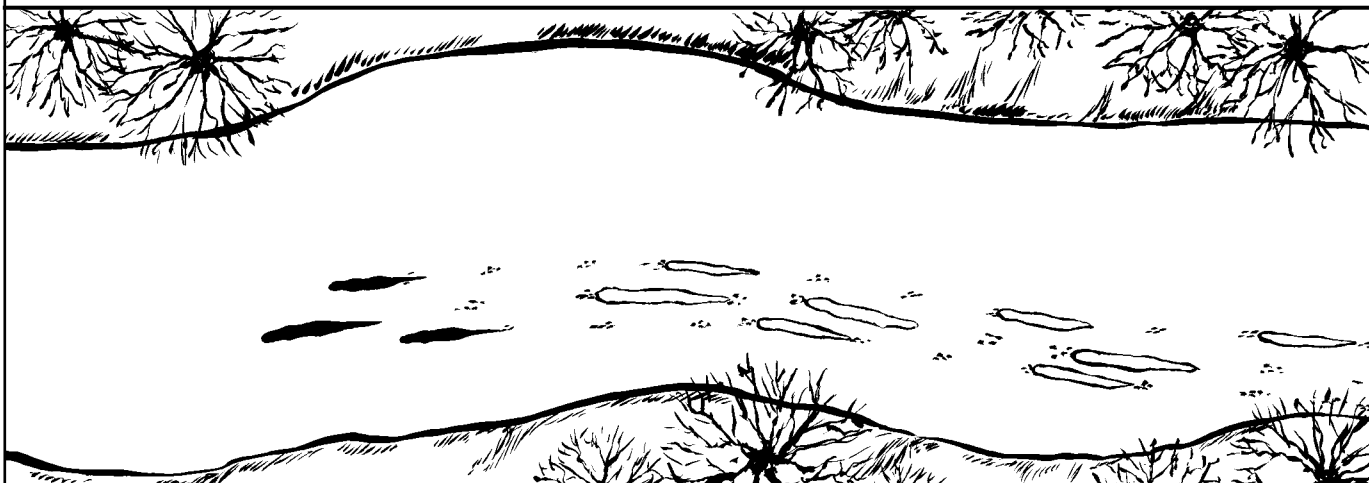

# Assessing Otter Damage

While otters cause some damage to fish populations in commercial hatcheries, impoundments and streams, and can leave unsightly messes on boats and swimming docks, they are often wrongly blamed for problems caused by other animals and natural phenomena. Before developing a plan of action to control otters, you should first determine that these animals are indeed the source of the problem.

## Defining objectives

If you're in the commercial fish-farming business, you will want to discourage otters from entering your facilities, and eliminate those that do. However, if you own a pond or lake for fishing and aesthetics, you need to consider your fisheries

management objectives before assessing your otter situation.

The fertile soils in north Missouri make ponds and lakes very productive. An average farm pond in this part of the state normally sustains between 300 to 500 pounds of fish per acre. Scaled fish species that readily reproduce in ponds, such as bass, bluegill and crappie, should sustain themselves in the face of occasional otter depredations.

Channel catfish populations that must be sustained through periodic supplemental stockings are most susceptible to population declines, and are sometimes eliminated by otters. According to studies, catfish are more susceptible to otter predation and may be targeted by otters in farm ponds because these fish don't rely on cover and are easier to

find. Catfish are especially susceptible during the cold winter months when they are more lethargic.

If you don't manage for channel catfish, otters probably are not a problem and you can enjoy them along with the diversity of other birds, mammals, reptiles and amphibians that frequent your pond.

## Natural phenomena

Finding partially eaten fish carcasses along the shoreline isn't necessarily a sign of an otter problem. Fish that die from natural phenomena float to the surface of the pond or lake and drift into the shoreline making them available to raccoons, skunks, mink, opossums, herons and other fish-eating animals.

A little detective work is necessary to determine whether the

### Otter tracks

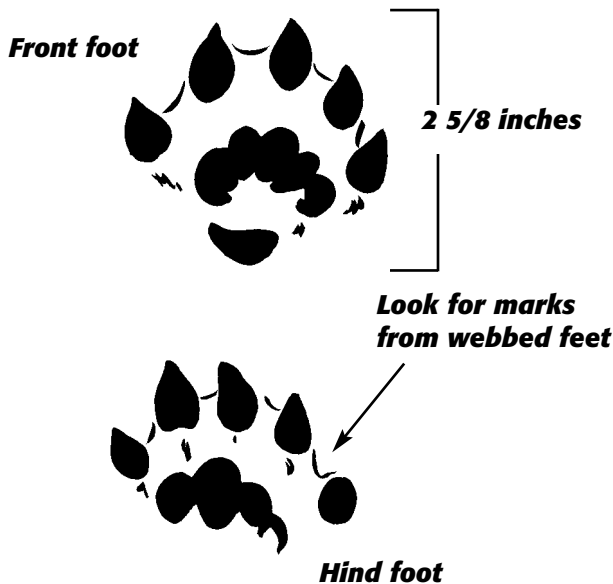

### Beaver tracks

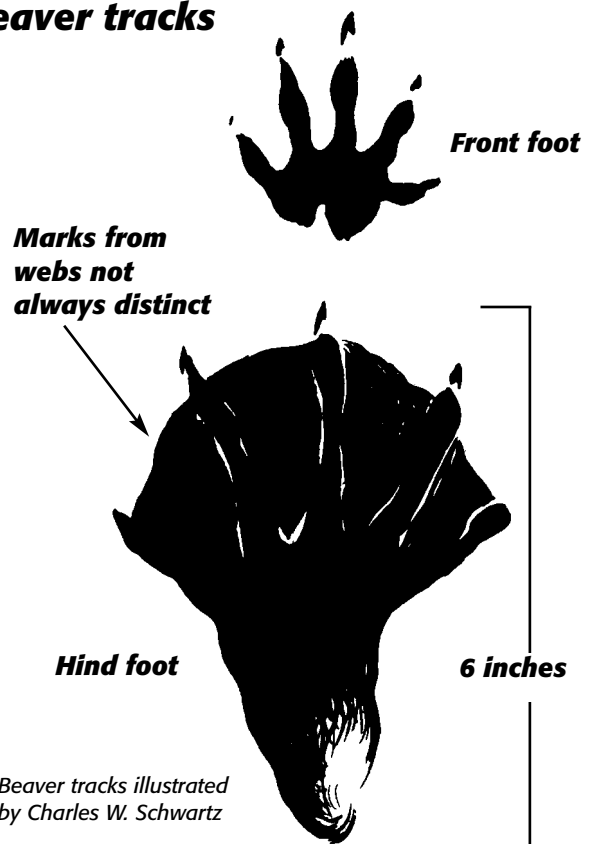



kills are the result of otters or some other cause. First check the depth of your pond. Aging, shallow ponds less than 8 feet deep are susceptible to fish kills caused by low dissolved oxygen levels during extreme conditions in summer and winter. These fish kills are generally associated with rapid growth of microscopic plants called phytoplankton, which further lowers the oxygen level in the pond if large quantities of the plants die and decay over a short time.

Because fish can succumb to a variety of parasites, illnesses and disease, check any dead and dying fish for parasites. Disease problems can strike individual fish or be widespread, depending on the density of the population and environmental factors.

### Otter sign

While the best indicator of otter presence is a direct sighting, be

sure you aren't confusing them with other semi-aquatic mammals, such as beavers or muskrats. *Remember: Otters are fairly large animals, much bigger than muskrats. The cylindrical body shape and long narrow tail help distinguish otters from the stouter and rounder beaver with flat scaly tails.*

If you haven't actually seen an otter but suspect one is nearby, you should look for signs they've left behind. Fresh tracks or droppings are the best clues that otters are frequenting an area. Droppings usually are easier to identify than tracks because grassy banks and shorelines can make detecting and identifying tracks difficult. See the habits section on page 4 for help in identifying otter scat.

Snow cover on iced-over lakes, streams and ponds makes it easier to identify otter tracks, slides, droppings and remains of fish that otters have eaten. Otters generally leave the heads of catfish intact

along the shoreline. Scaled fish may be completely devoured so that only a few scales, fins and blood on the snow is all that is left. Sometimes otters will leave large partially eaten fish laying on the bank near holes in the ice or around their dens.

In snow or muddy conditions, look for the otters' characteristic gait. Otters usually take two or more bounds, and then slide on their bellies in the snow. Sometimes the mark of the dragging tail will show along with tracks in the snow or mud, especially when the otter is walking.

Latrine sites are almost always evident around the shoreline of a pond or lake that otters are frequenting. Usually, these sites will be on the highest banks of the dam, or on a point that extends out into the water. At dams, look for a direct path from the stream. On top of the dam near this trail is a good place to look for latrine evidence.

### Mink tracks

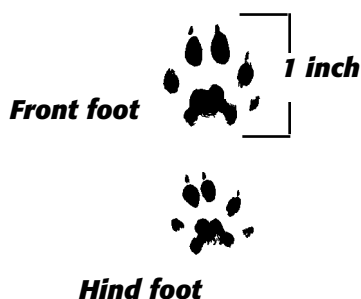

### Muskrat tracks

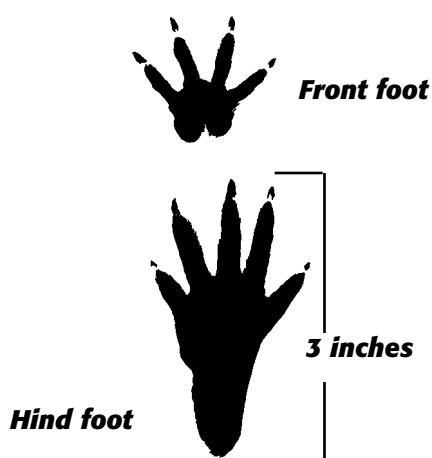

### Raccoon tracks

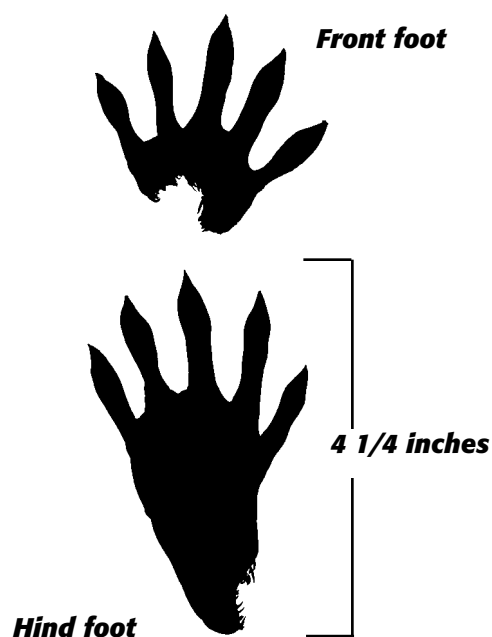

To be certain otters are in the area where damage is occurring, compare the otter tracks, far left, with those of other animals commonly found around the shorelines of ponds and streams.

## Damage Prevention

Once you have determined that otters are causing damage, you can develop a plan to resolve the problem.

Because otters don't build their own dens, they usually won't stay in a pond unless a den is present for them to use. Otters typically den in abandoned beaver lodges, as well as muskrat dens and houses. Removing beavers and muskrats in the pond or nearby stream and destroying the dens and lodges may discourage otters.

Sometimes otters den in inlet and outlet tubes of impoundments. If so, they should be sealed with barriers and flap gates to exclude otters while still allowing the water to flow.

It is difficult to prevent otters from entering ponds and eating fish. Maintaining some aquatic weeds or placing brush piles in the pond will provide cover to help fish escape.

Fencing also is an option, although it may be too expensive

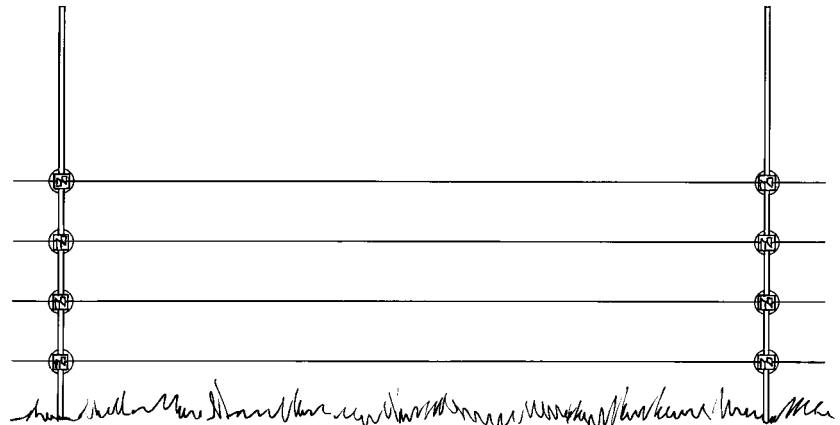

*To exclude otters by using an electric fence, place the first strand 4 inches from the ground and the rest at 4- to 5-inch intervals.*

and impractical in some areas. When practical, a properly maintained, hi-tensile electric fence can be effective. At least four strands, spaced at 4- to 5-inch intervals, should be kept tight and clear of any grass or weeds that could ground the electric charge. The bottom wire should be low to

the ground, and the spacing of the wires should be close enough so otters can't get under or between them without getting shocked.

Permanent welded-wire fences also may be useful to keep otters out of a pond, but the effectiveness of this type of fence needs further testing.



*Electric fences can keep otters from entering a pond, but must be maintained to be effective.*

# Damage Control Techniques

The best time to remove nuisance otters from your property is during the regular trapping season when it is easier to find expert trappers to do the job for you. It also allows you or the trapper to make use of the resource by selling the pelt.

If this timing is not possible, rule 4.130 of the *Wildlife Code of Missouri* allows landowners to use lethal methods such as shooting or trapping any time of the year to remove nuisance otters. Under this provision, otters may be controlled only on the owner's property to prevent further damage to lakes and ponds. The rule does not permit landowners to remove otters from streams that run through their property outside of trapping season, even if the landowners believe the animals are taking fish from the stream.

Nuisance otters trapped out of season under this provision must be reported to a conservation agent within 24 hours and disposed of in accordance with the agent's instructions.

## Shooting

Otters are often active during daylight hours and are sometimes seen in farm ponds feeding on fish. Because they have poor eyesight

out of the water, they can be stalked by a skillful shooter at these locations. Otters will sometimes notice a motionless person on the bank and move closer to get a better look, enabling a person to safely shoot them.

Take care when shooting around water. To avoid bullet ricochet, never shoot a rifle at flat water at a low angle. It is best to use a shotgun or wait until a safe rifle shot away from the water presents itself.

## Live trapping

Although live trapping and releasing animals at another location may sound like a good way to solve a nuisance otter problem, it usually doesn't work. Relocating otters can mean transferring the animals to another location where they may again cause problems. Also, most landowners do not want someone else's problem otters released on or near their property.

In some cases where ordinances prohibit the use of other types of traps, live trapping may be the only option. Keep in mind, however, that live trapping and relocating otters is difficult. Otters aren't readily caught in conventional cage traps, and individuals must be moved a long distance to prevent their return to

the same area.

The otters that were relocated during Missouri's restoration effort were caught with foot-hold traps. However, handling live otters caught in these traps can be risky and requires special care and expertise by trappers to avoid injury to themselves and the animal. Consequently, a foot-hold trap is not a practical live-catch tool for the average person.

Only a few cage traps are specifically designed for trapping river otters. Be sure the trap is at least 48 inches long. Don't use conventional traps designed for raccoons. These traps are too short, and the otter's tail will block the door and allow the animal to escape.

An effective otter trap can be built by modifying and combining two 12 x 12 x 36-inch Tomahawk cage traps. This trap, with a few modifications to reinforce and speed it up, can be effective at crossover trails. See page 10.

If the path is not already restricted by brush or other objects, use sticks to lead otters into the trap. Be careful not to tramp down a trail around the trap as you check them or the otters will take your trail instead of going into the trap.

## Otter traps: where to use them

Type	Channels	Streams	Crossover trails	Beaver dens	Latrine sites	Pocket set
Body-grip <sup>2</sup>	✓		✓	✓	✓	✓
Foot-hold		✓ <sup>1</sup>	✓		✓	✓
Snare <sup>3</sup>	✓ <sup>2</sup>		✓ <sup>3</sup>			
Cage			✓			

<sup>1</sup>Must be used only during the regular trapping season

<sup>2</sup>Must be completely underwater

<sup>3</sup>Can only be used on dry land with special permission

## How to modify Tomahawk live traps for otters

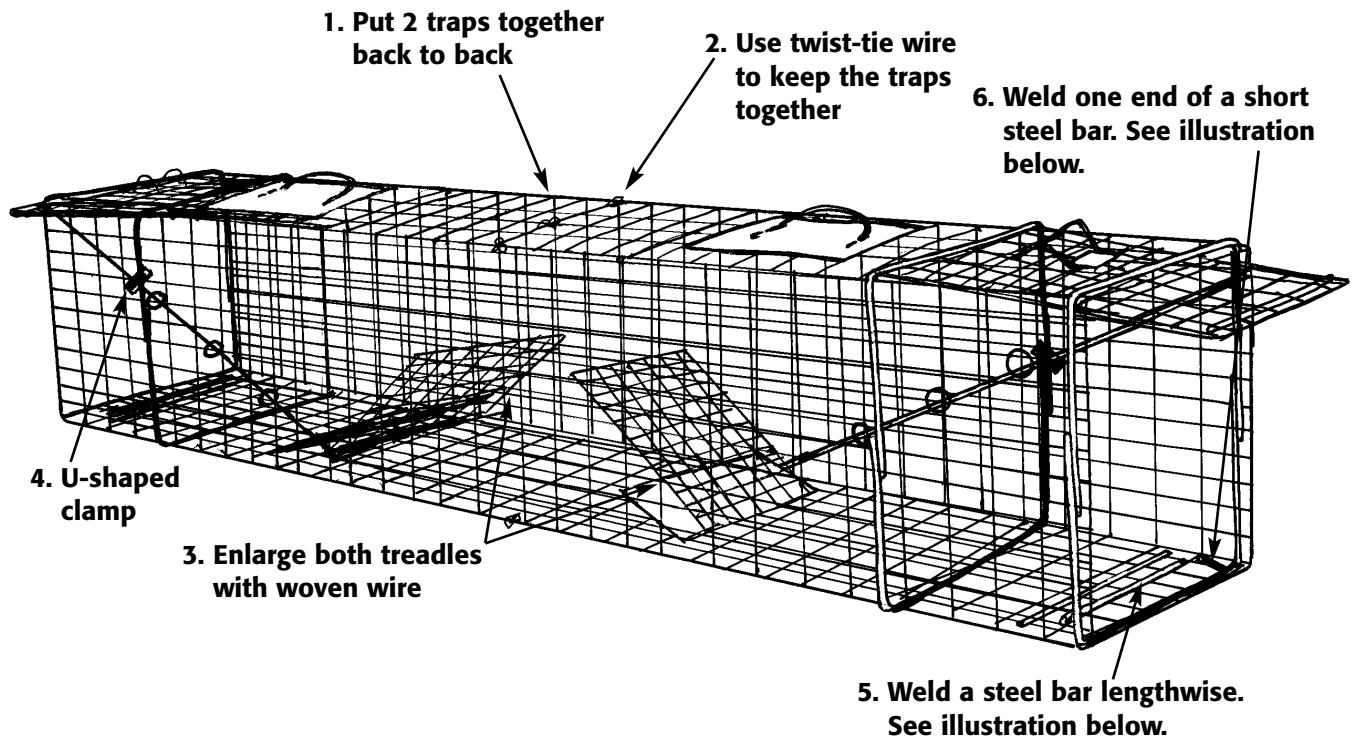

1. Remove the back ends of two traps. Save the two pieces of welded wire about 9 inches by 8 inches to use in step 3.
2. Twist-tie wire at several places around the top, bottom and sides to attach the traps back to back to create a 72-inch, double-door trap. By attaching the traps in this way, they can be easily taken apart for adjustment if necessary.
3. To ensure that the otter will activate the modified trap, you will need to enlarge the treads. To do this, drill holes in the metal treads and attach the two pieces of welded wire from step 1 to the metal treads using small pieces of tie wire. *Note: The welded wire can get bent when an animal is caught in the trap and may have to be fixed before the trap is used again. Be sure to bend the wire so the animal won't get cut by the ends of the welded wire.*
4. The lengthened treads cause the trap to have a hair trigger. To solve this, attach a metal U-shaped clamp through the side of each trap so that the clamps fit around each steel rod that runs from the door to the treadle. Tighten the clamp to get the right tension.

5. Weld a steel bar to the bottom front of each trap so the doors lock down when they fall. Be sure the doors fall hard enough to slip over the steel bar and that they lock down every time. *Note: If the trap does not snap down quickly, attach a long, screen-door spring (not shown) from the side of the trap to the door. Adjust as needed.*
6. Then weld one end of a short (about 1 1/2 inches) steel bar lengthwise to the bottom front of each trap. Point the bar up slightly to keep the trapped otter from pushing the doors open, but not so much that the doors won't close. See below.

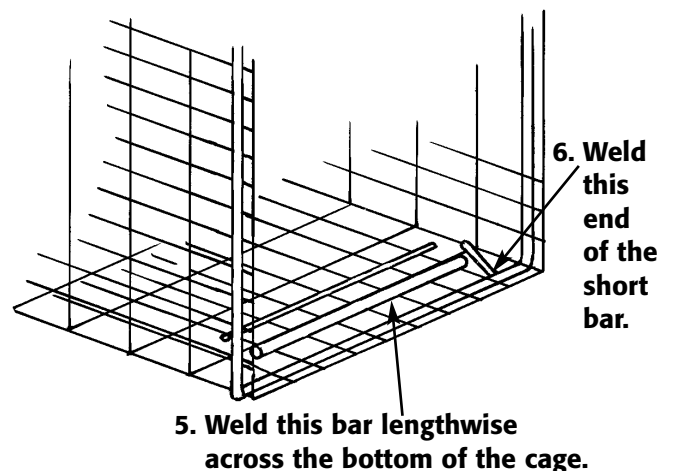

## Body-grip traps

Body-grip, or Conibear, traps are designed to catch an animal around the body and kill it almost immediately, much like a common rat trap. These traps are easily placed in a variety of locations and are the most effective lethal method for catching furbearing animals that swim in the water.

Body-grip traps are made in a variety of sizes to accommodate several different animals. Sizes #220, #280 and #330 are commonly used for catching otters, with the larger #330 generally producing the best results. All body-grip traps for otters must be set underwater.

Otters are fast, powerful animals and only good quality traps with strong springs in good working condition should be used. Inspect traps annually, and replace weak springs and broken triggers.

Because body-grip traps large enough to catch otters are powerful, be careful while using them. They are difficult to set by hand so most people use a trap setting tool to compress the springs.

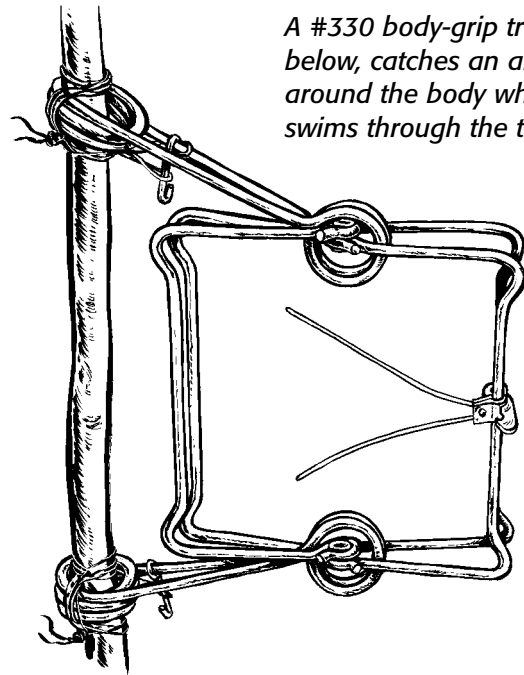

A #330 body-grip trap, below, catches an animal around the body when it swims through the trap.

## Foot-hold traps

Foot-hold traps have two jaws that grasp the animal's foot. These traps can be used to hold the animal alive until the trapper checks it each day, or in a set that drowns the animal within a few minutes after it is caught.

Like body-grip traps, foot-hold traps come in a variety of sizes. Be sure all traps are in good working condition. For otters, use the foot-hold traps shown here:

- a #1 1/2 offset, laminated-jaw, coil-spring trap

- a #11 offset, laminated-jaw, long-spring, foot-hold trap

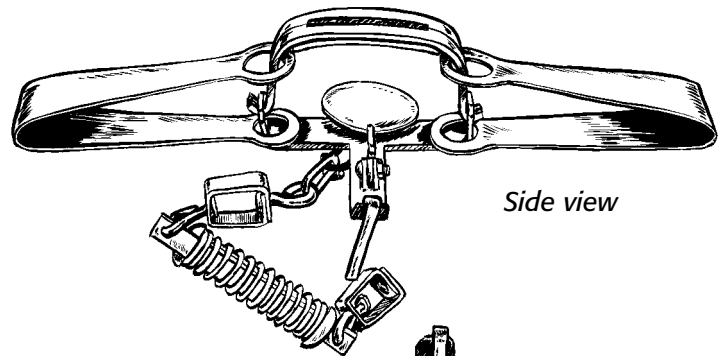
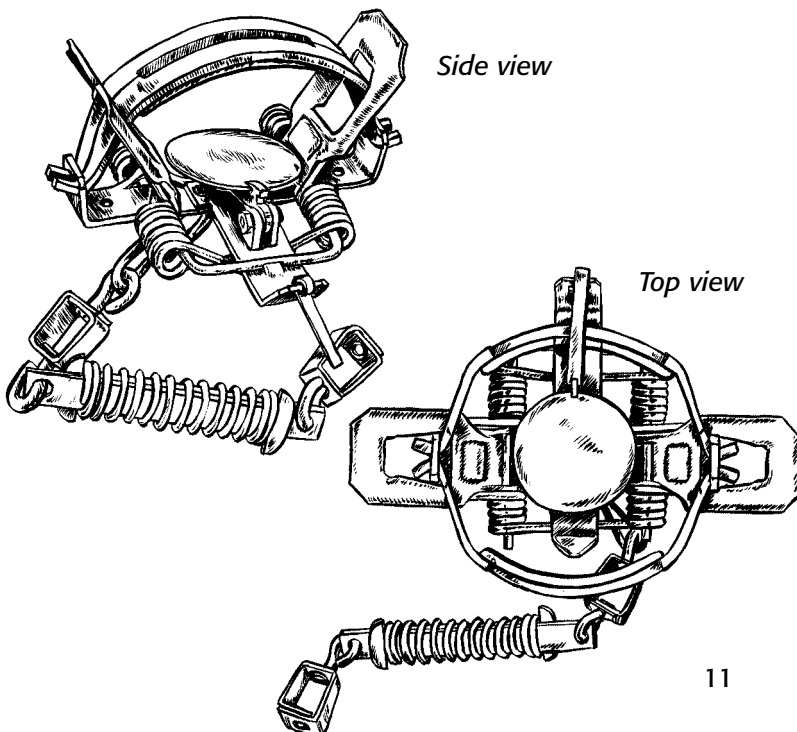

Side view

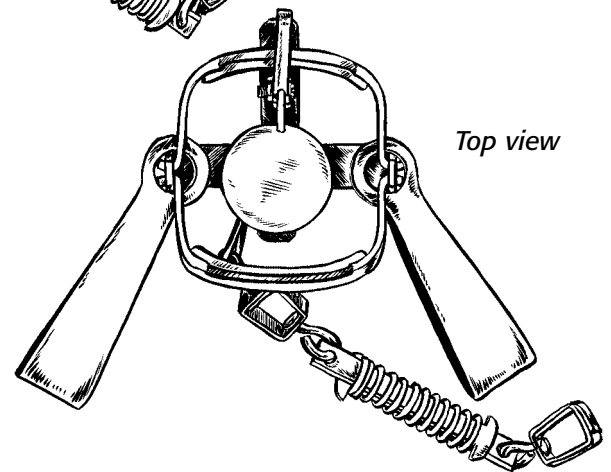

Top view

**Using foot-hold traps  
in streams with mud  
or sand bottoms**

Foot-hold traps can be used as a lethal technique for catching otters in streams only during the regulated trapping season. Use cured wooden stakes to hold the otter underwater so it will drown quickly. Use the technique on this page that best fits your situation.

A. At crossover trails, drive a cured, sturdy stake firmly into the stream bottom in water that is 3 to 4 feet deep. Drive a similar stake near where the trap is set. Use a wire cable or twist four strands of 16-gauge wire into a cable, pass it through the sliding lock on the trap chain and tie the ends of the cable to the two stakes where they enter the ground. This setup leads otters to deep water, and the slide lock keeps them from returning to the surface.

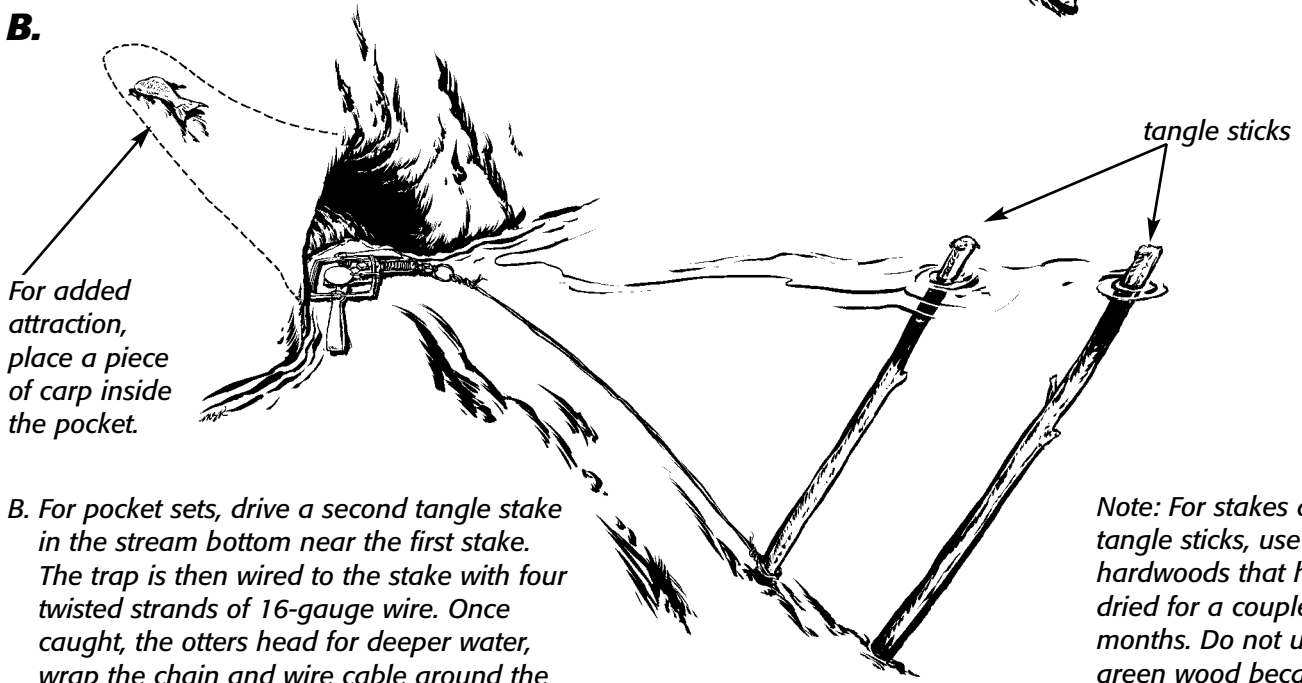
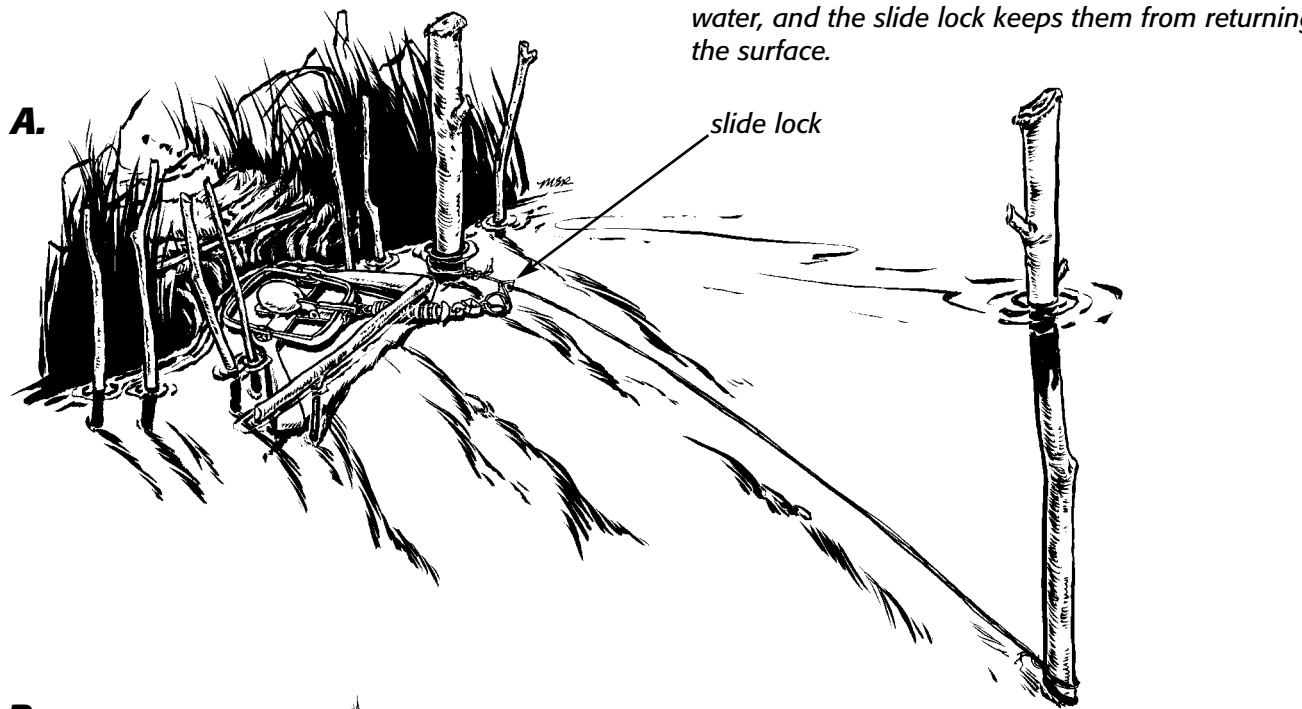

B. For pocket sets, drive a second tangle stake in the stream bottom near the first stake. The trap is then wired to the stake with four twisted strands of 16-gauge wire. Once caught, the otters head for deeper water, wrap the chain and wire cable around the tangle stake, and drown. See page 20 for more details on pocket sets.

Note: For stakes and tangle sticks, use hardwoods that have dried for a couple of months. Do not use green wood because beaver are likely to cut them.

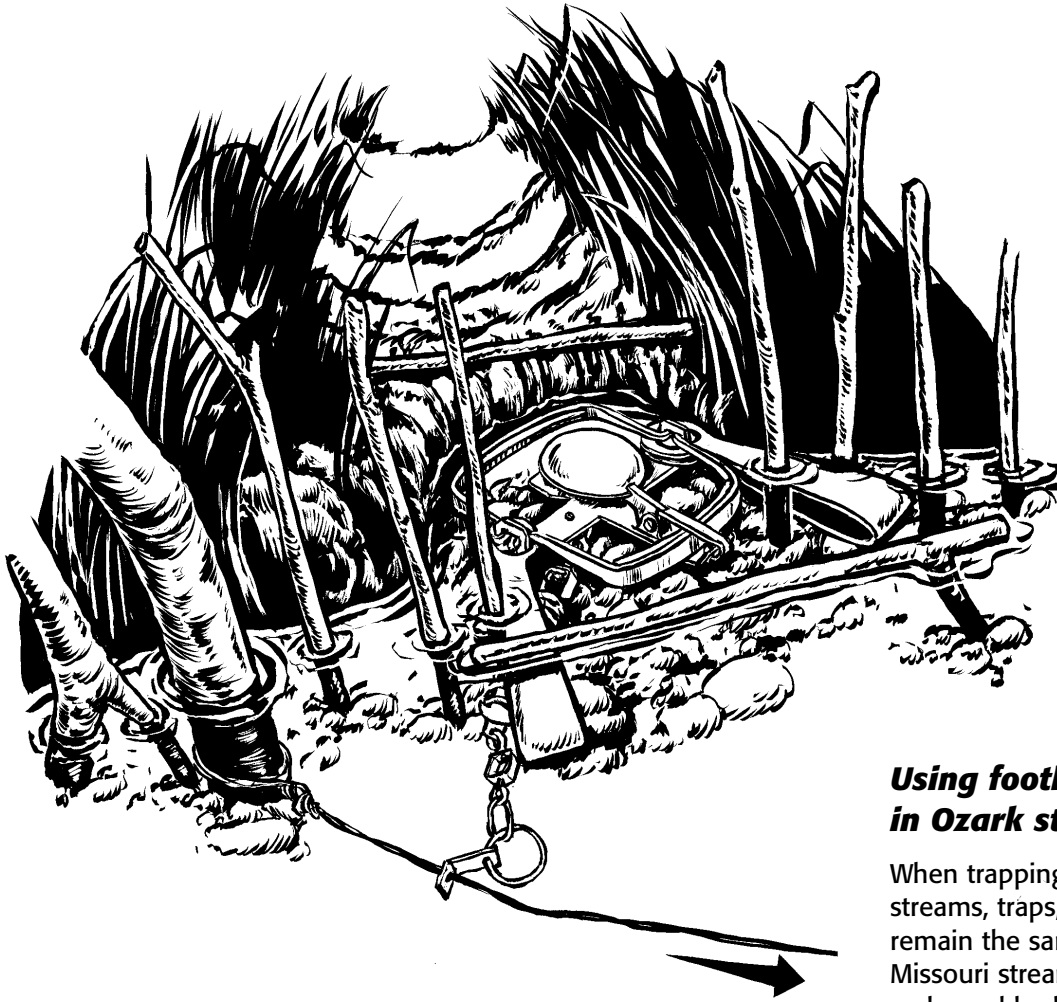

***Using foothold traps  
in Ozark streams***

When trapping in clear, rocky Ozark streams, traps, sets and equipment remain the same as for northern Missouri streams; but the gravel, rocks and bedrock require different approaches for securing the traps.

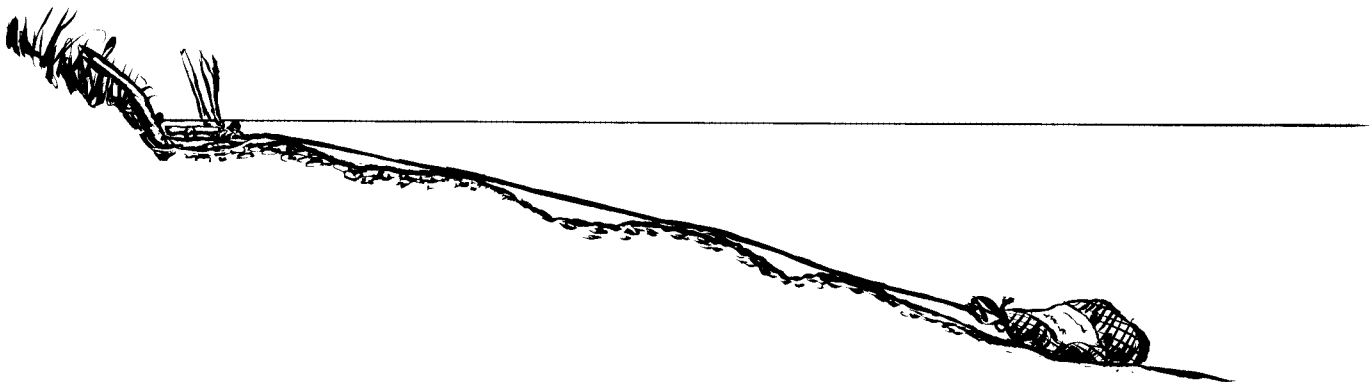

*For drowning sets, traps are generally tied to large rocks or tree roots near shore and to a big rock in deeper water. Some trappers save nylon-mesh onion bags throughout the year. At the trap site, they fill these light, sturdy and inexpensive bags with rocks, attach the slide wire and toss the weighted bag into 3 or 4 feet of water.*

## Snares

Snares are an effective way to catch nuisance otters. These simple, yet effective tools, are made of loops that cinch down on the animal's body when it walks or swims through the device.

A good quality snare for otters can be made with a 24-inch length of 3/32 galvanized or stainless steel aircraft cable, a sliding lock and a swivel. The loop in the snare should be 5 or 6 inches in diameter. Use

No. 9 wire to support the snare at the site. Secure the snare to a firm object like a tree or root with four strands of bailing wire or a light cable. Snares should only be used once because the cables kink after one catch.

*Note: While snares can be used effectively on dry land or in the water, it is illegal to use snares on land unless issued a permit by a conservation agent or wildlife damage biologist.*

Snares are inexpensive and easy to use. Their main disadvantage is that the most effective snare locations for otters on land also are frequented by non-target animals like raccoons, minks, muskrats, as well as domestic dogs and cats. In contrast, snares used in water sets catch very few non-target animals.

*Note: It is imperative that neighbors and hunters know when snares are being set on land so they can keep their pets out of the area until snares are removed.*

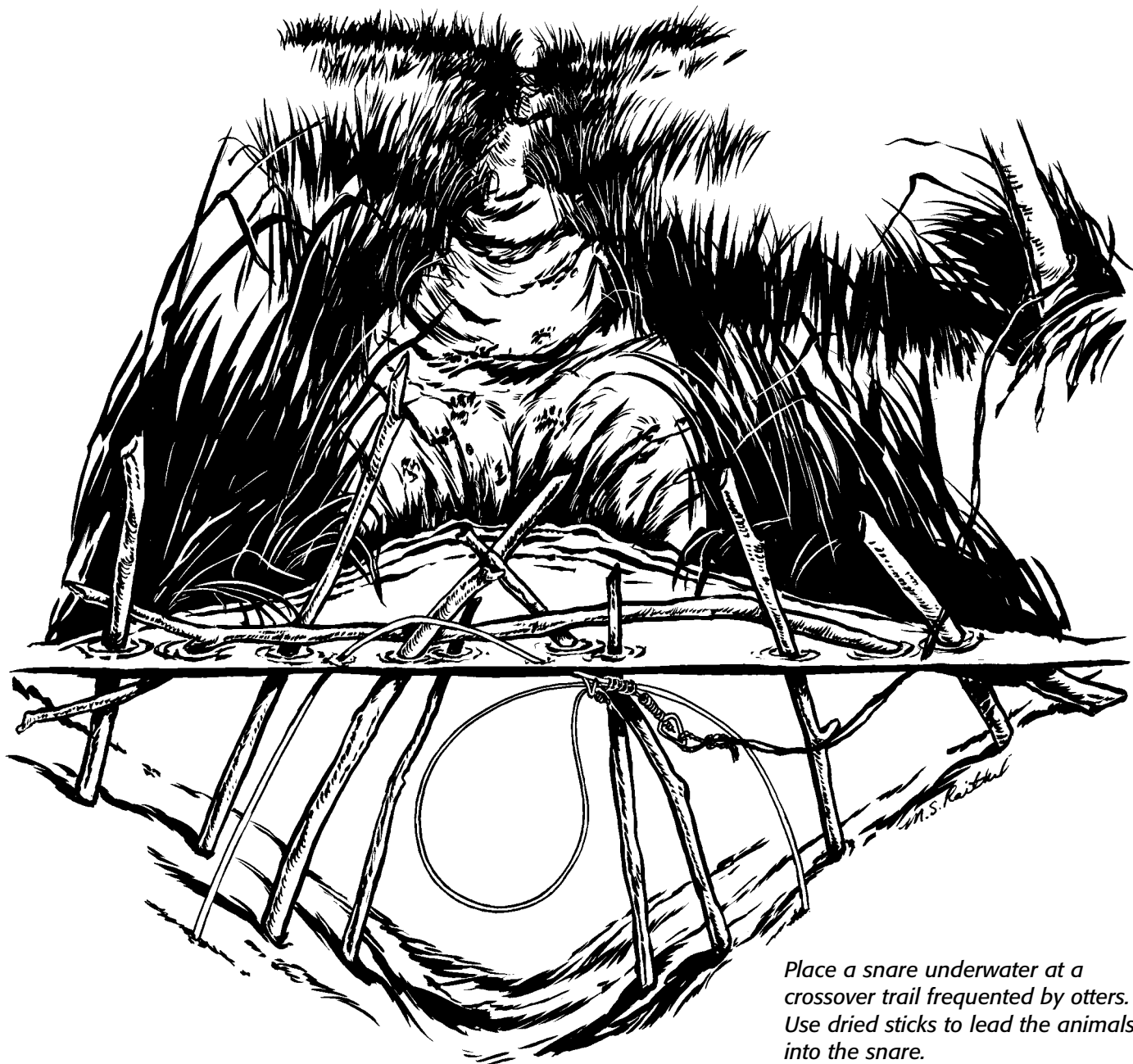

*Place a snare underwater at a crossover trail frequented by otters. Use dried sticks to lead the animals into the snare.*



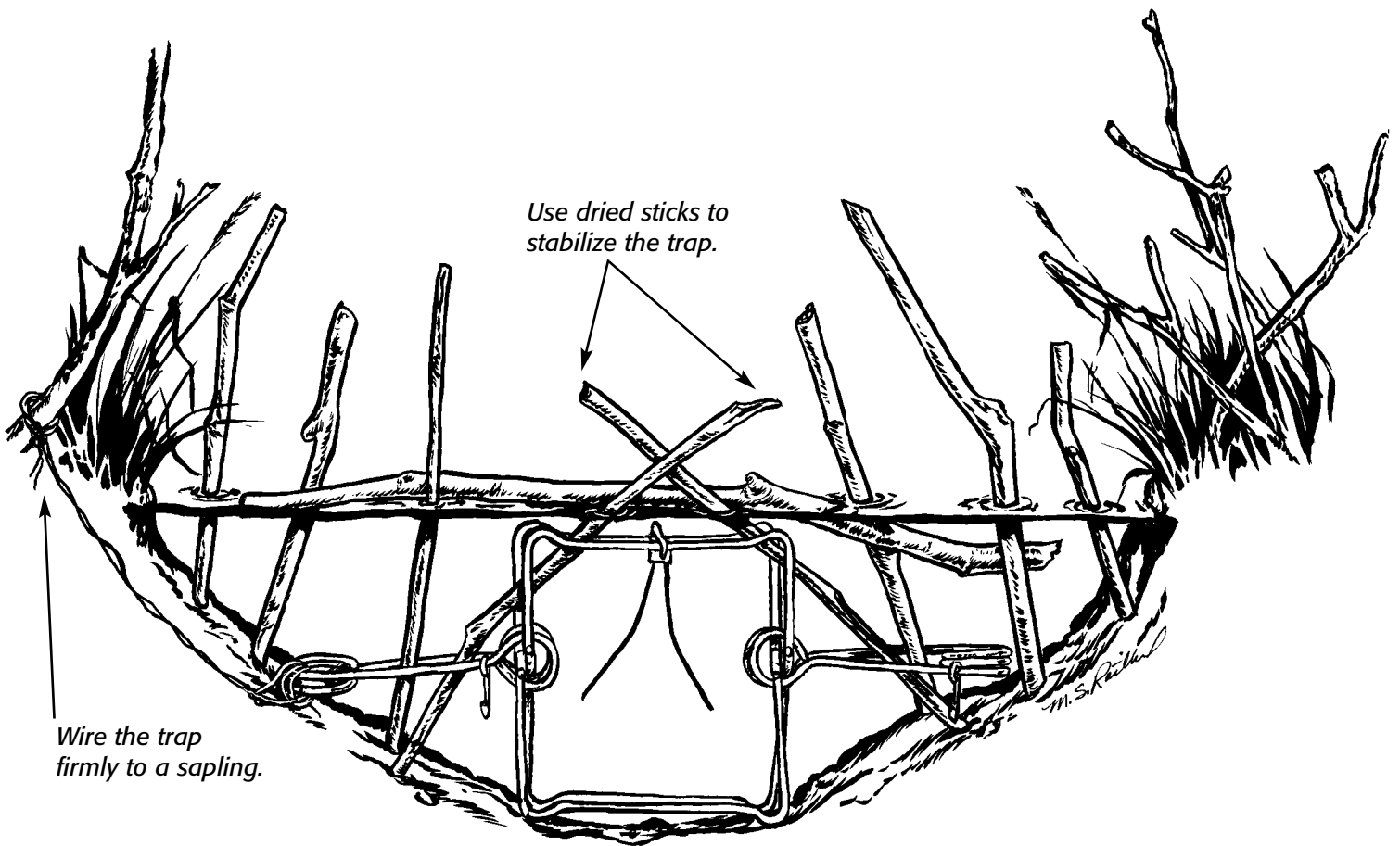

*In a shallow channel, use a body-grip trap as shown above. Use dried sticks to lead otters into the trap. Dig a deeper channel if needed to get the trap completely underwater.*

## **Set Locations**

Setting a trap in the right location is essential to catch a specific species. Match the sets listed below with your situation and location.

### **Channel sets**

Channel sets are probably the most effective for catching otters. As the name implies, a trap or snare is located in a narrow stream channel or in a continuous depression created by beaver activities at the upper end of a lake. Otters use these areas to swim from one location to another.

Body-grip traps can be used effectively in both a pond or a

nearby stream. *Remember: Body-grip traps must be set completely underwater. Use a spade or shovel to deepen the channel if needed.*

It is important to choose the right location for a channel set. Look for tracks on mud banks or sand bars at the upper and lower ends of pools, which indicate where otters are entering the water and swimming in the channels. One of the best locations is just below a beaver dam where beaver, as well as otters, are crossing the dam.

Place the trap in the channel with the springs out to the side and the trigger on top. The trigger wires should be spread to fill as much of the target area of the trap as

possible. The trap may be set on the bottom of the channel if the soil is firm. If the soil is soft, angle the springs down 45 degrees to support the trap above the bottom to keep it from being slowed by silty sediments.

Use two dried sticks, 3/4 to 1 inch in diameter, to stabilize the trap. Push the sticks into the mud so they cross over the top of the trap, pass between the corners of the jaws, through the springs and firmly into the mud. Always use dried sticks for guides to keep beaver from cutting them and ruining the set. Wire the trap firmly with two strands of 16-gauge wire to a nearby sapling or stake.

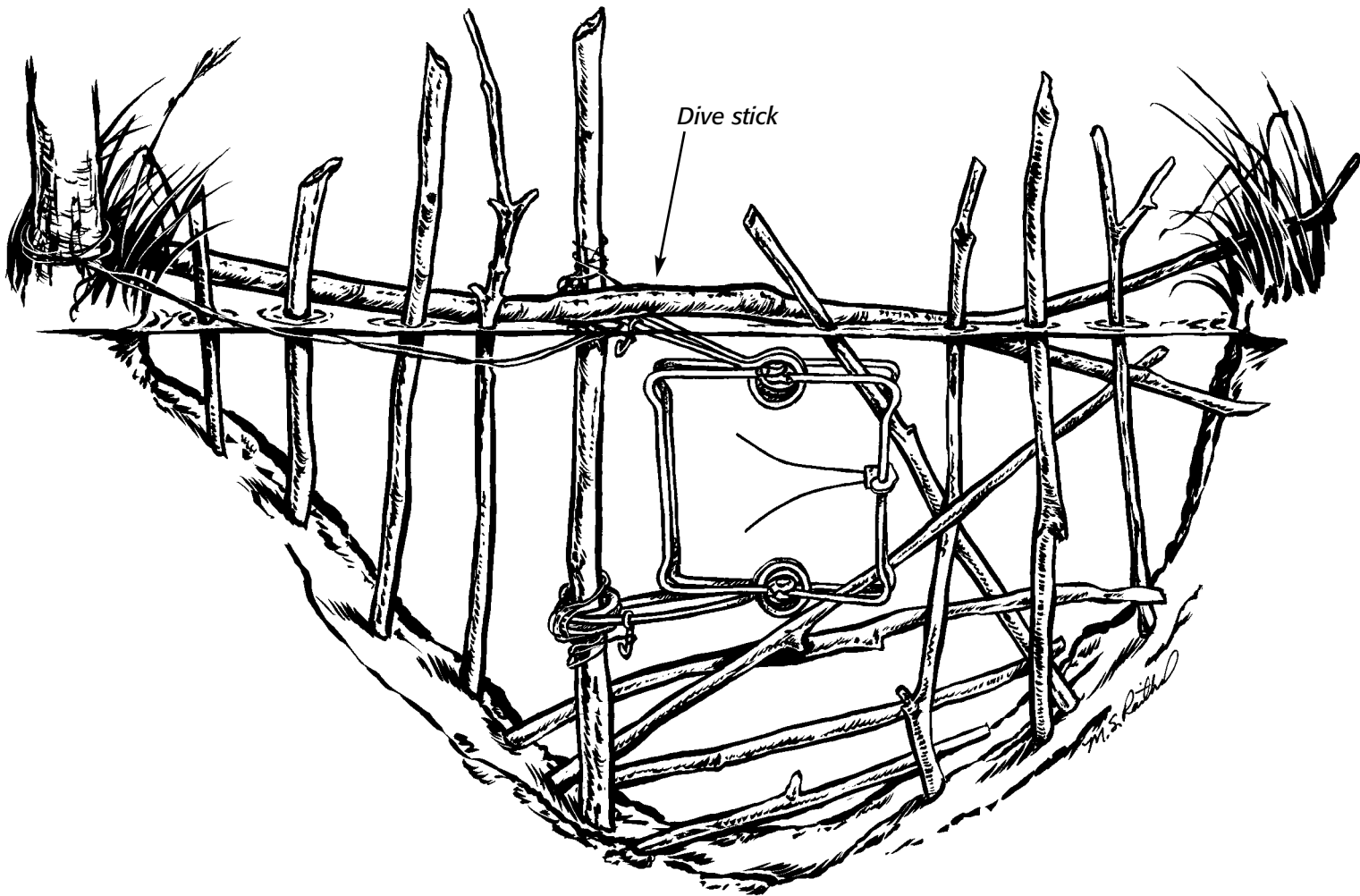

*In a deeper channel, set the trap on a pole. To get otters to enter the trap use a dive stick and plenty of fencing. Too much fencing always is better than not enough.*

Once the trap is in place, narrow the channel on either side by constructing a fence with dry stakes to force otters to swim through the trap. To do so, simply push the sticks in the mud starting next to the support stakes on either side of the trap. Continue the fencing to the adjacent stream banks. If the banks slope gently and the otters are traveling over land rather than through the water, put brush and other debris on the banks to keep them in the water.

Too much fencing is better than not enough. The fencing will change the appearance of the area, but otters are used to their surroundings changing with every

high flow in the stream. To encourage otters to dive through the trap, add sticks across the top of the trap.

For deep channels, wire the springs of the body-grip trap to a long pole. Pull both springs at a 45-degree angle away from the trap. Wire the trap firmly to the pole. With the trap attached, firmly push the pole in the mud and place dried sticks to fence the channel below the trap. Wire the top spring safety catch so it doesn't interfere with the trap's action.

Check the trap daily and remove any leaves or debris so it will function properly. Don't worry if you don't catch anything right away. Otters

often leave an area, then return a week or two later. Because otters tend to travel in groups, several sets along the length of a channel can result in multiple catches.

Snares can be used effectively in channel sets in the following ways:

- If the water isn't too deep, set the snare halfway in the water.

*Note: Before using snares that are not completely underwater, you must get authorization from a wildlife damage biologist or conservation agent.*

- If set completely underwater, use guide sticks, as well as a dive stick, to get otters to swim through the snare.

## Crossover sets

Like most animals, otters are creatures of habit. They routinely use the same waterways and trails crossing from one body of water to another. Sometimes these crossover trails are obvious. At other locations, they may be more subtle. Crossovers commonly traverse the top of pond dams where otters travel from the stream below to the pond above. Often these trails will be in a direct line with the stream below the dam; however, natural obstructions such as logs, brush piles and fences may cause them to take a circuitous route.

Obvious crossovers are well worn and are usually 4 to 6 inches wide. If beavers or raccoons are in the area, they will use the trails as well. On closer inspection, you will likely find otter scat nearby, usually on a high point at the top of the pond dam. Tracks may be visible in the mud where the trail meets the pond or stream edge.

Occasionally beavers will make a groove in the bank where the trail meets the water. This well-worn path is a ready-made site for a #330 body-grip trap. Set the trap in this groove as described in the channel set section on page 15. Excavate the groove with a shovel if it is too shallow or narrow.

If there is no groove at the site, make one yourself. Your excavated trench doesn't have to extend all the way up the bank and into the water. Just be sure to get the trap underwater and line it up with the trail.

As in channel sets, use sticks and large logs to completely fence the area on either side of the set to

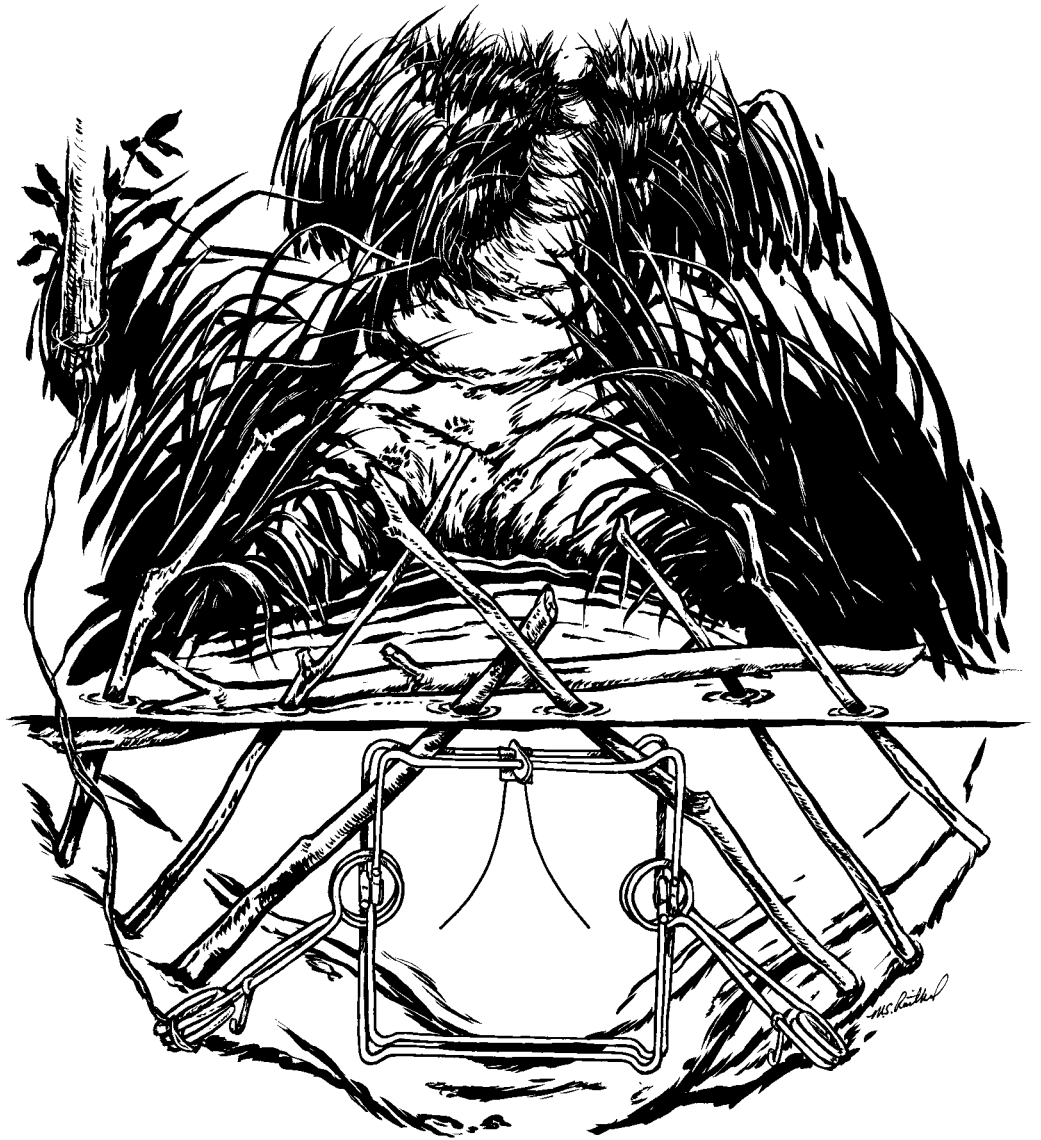

*A #330 body-grip trap set where the trail meets the water is a ready-made site for a crossover set. Use dried sticks to direct otters into the trap.*

encourage otters to go through the trap. If you find a pool of water on the stream side of the dam, make a similar set at that location, too.

In areas where no obvious trails can be found but otter sign abounds, you can construct a crossover trail. First scout the area, and select a logical location. With a saw or axe, remove obstructions such as logs, brush and shrubs. Walk over the path several times matting the grass by dragging your feet to make the trail look well

worn. The trail only needs to be 6 or 8 inches wide. Then dig a groove and make an underwater trap set as described above.

To make the crossover trail especially enticing to otters, scoop mud from the pond or stream bottom and smear it on the bank and up the trail several feet. The more muddy it looks, the better. Otters notice and use these muddy trails because they are curious and will take advantage of an active trail used by other otters and beavers.

For added appeal, rub the flesh of cut carp, shad, buffalo or other fish along the groove and into the mud, leaving lots of scales in the area. Some trappers carry otter scat from another location and place a pile of it on the bank. Balled up grass also will make it look like other otters are using the trail.

Snares also can be effective on crossover trails; but before using them on dry land, you must get authorization from a wildlife damage biologist or conservation agent.

Place the snare with a 5- or 6-inch loop in the natural or excavated groove. To support the snare, use No. 9 wire bent in a U shape with both ends stuck in the mud. Position the snare 2 inches off the bottom of the trench. Make sure no leaves or twigs interfere with its function. Securely wire the snare to a stake, sapling or root with wire that is at least as strong as four strands of twisted bailing wire. As with the body-grip set, use fencing to guide the animal through the snare and small upright sticks to conceal it.

If you need further help constructing or using snares, contact the wildlife damage biologist in your area. See page 26.

### **At beaver dens**

Otters routinely use both active and inactive beaver dens and lodges, but traps should only be set at the inactive ones unless you want to remove the beaver as well. Be careful around these dens because the water can be deep. Use chest waders to stay dry, especially in cold weather.

When ice covers the pond, dens and lodges may be the only

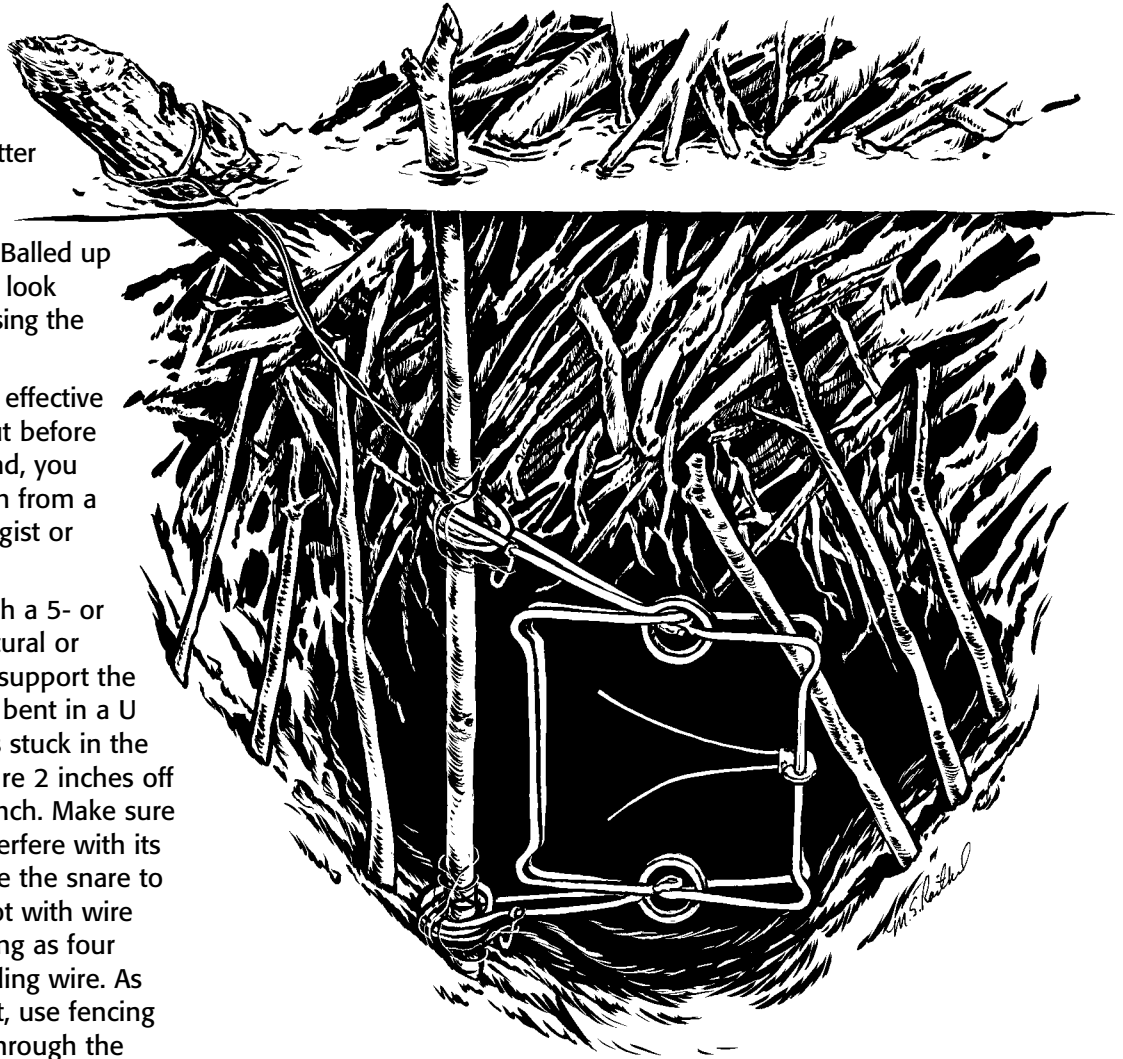

*Body-grip traps set at inactive beaver dens and lodges may be the only place to catch otters when ice covers a pond.*

locations where traps can be set. At active lodges, the beaver often keep the water open, giving otters access to fish under the ice. Otters seeking shelter in beaver dens generally leave plenty of droppings and other sign such as fish remains. If no snow covers the ice, look for strings of bubbles visible under the ice to indicate the locations of entrances to bank dens and lodges. Bubbles alone, however, are not an indicator of otter activity because beavers and muskrats leave them, too.

Den and lodge entrances are excellent sites to set body-grip

traps. Look for a shallow trench in the pond or stream bottom. You can feel the entrance to the den or lodge and the definition of the trench with your feet, or in shallow water with your hands. Place the trap in the trench, flush against the active entrance, supporting the trap with slender dry sticks pushed through the trap jaws and springs into the mud as described in the channel sets section on pages 15 and 16. In deep water, wire the trap to a long pole. Fencing with guide sticks may not be required unless the entrance is exceptionally large.

**At latrine sites**

Sites where otters defecate are called latrines. They may be up to 20 yards from the water's edge on the pond dam or higher points of land. Otters visit these sites every time they are near the pond. They play a role in the social structure of the otter population and are a form of scent marking.

Usually a trail leads from the water's edge to the latrine site. A trail can be enhanced or constructed by using the same methods as described in the crossover set section on page 17. Sometimes an opening through vegetation or tracks in the mud show where otters are entering and leaving the water. The mud-slicked trail will help entice otters to use it. A #330 body-grip trap set in an excavated groove in the bank similar to the crossover set works well at these locations. Use plenty of guide sticks and logs to force the otters to swim through the trap. Musk from otter or mink glands, or otter scat collected from another location, will help attract otters to latrine sites.

Close up of a latrine site

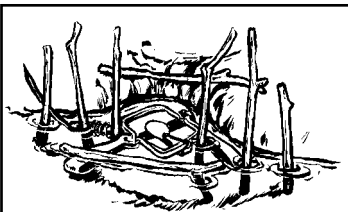
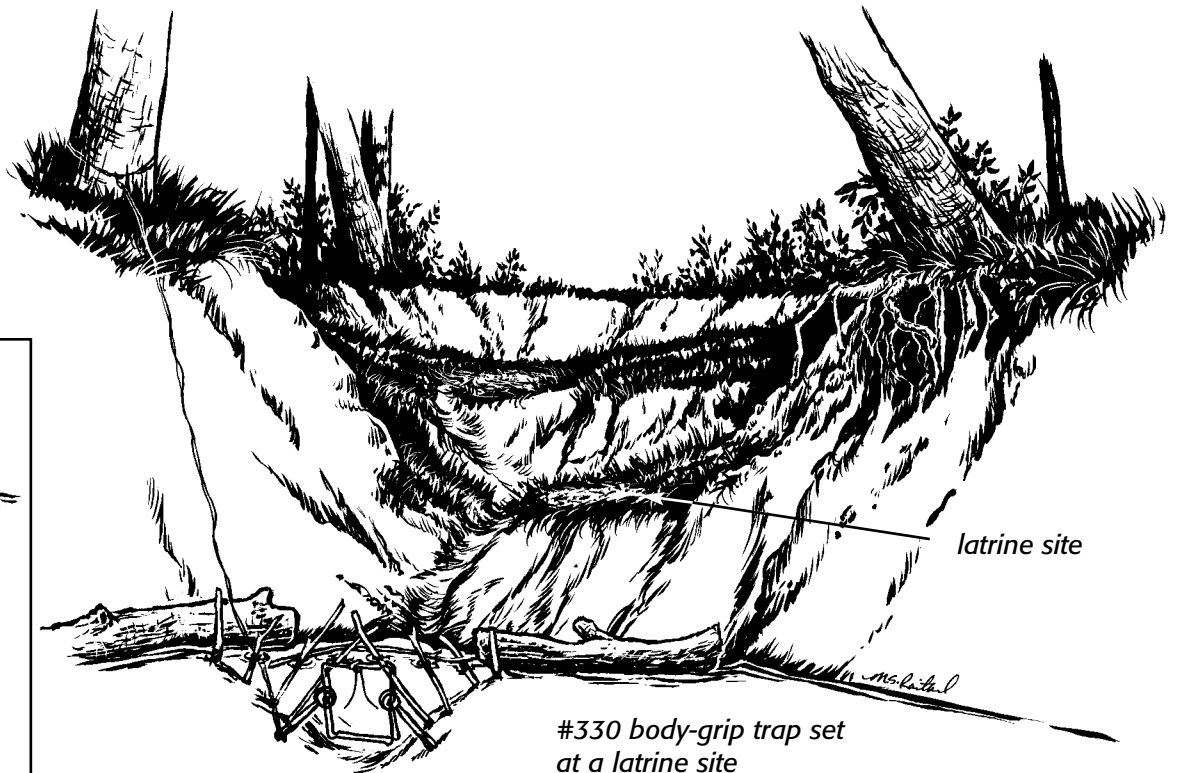
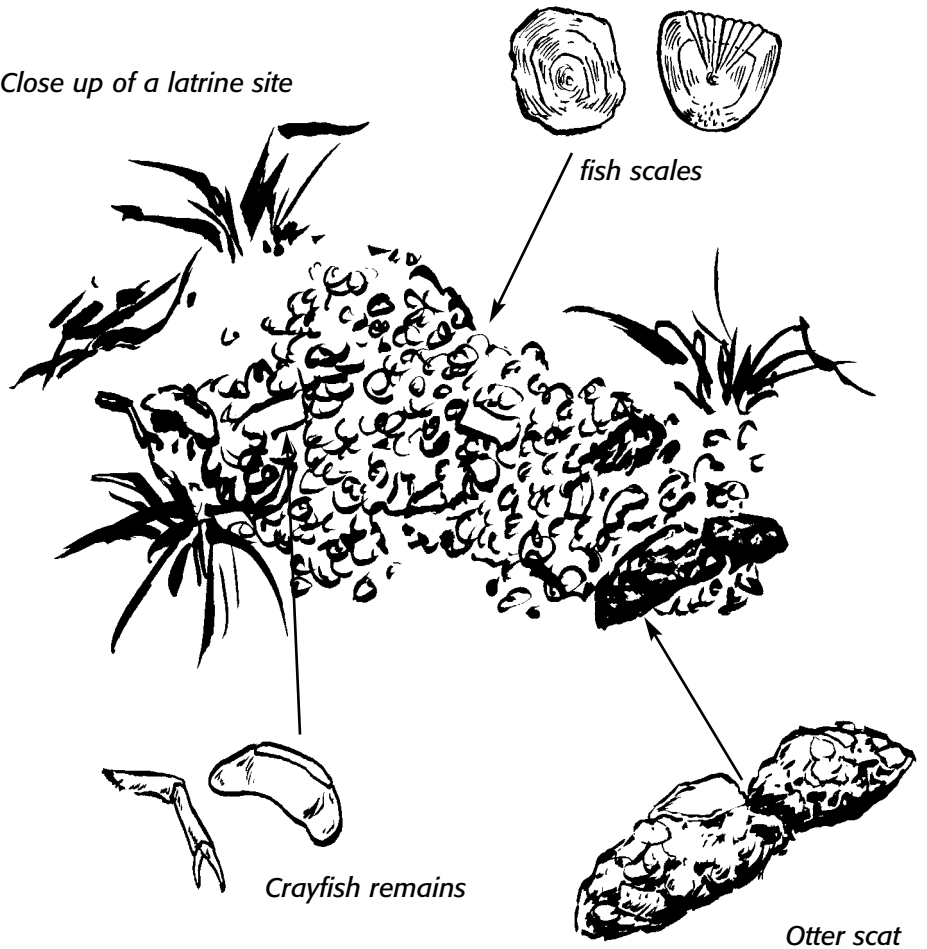

*If using a foot-hold trap at a latrine set, use plenty of sticks to get the otter to step on the trap pan.*

#330 body-grip trap set at a latrine site

## Pocket set locations on a stream

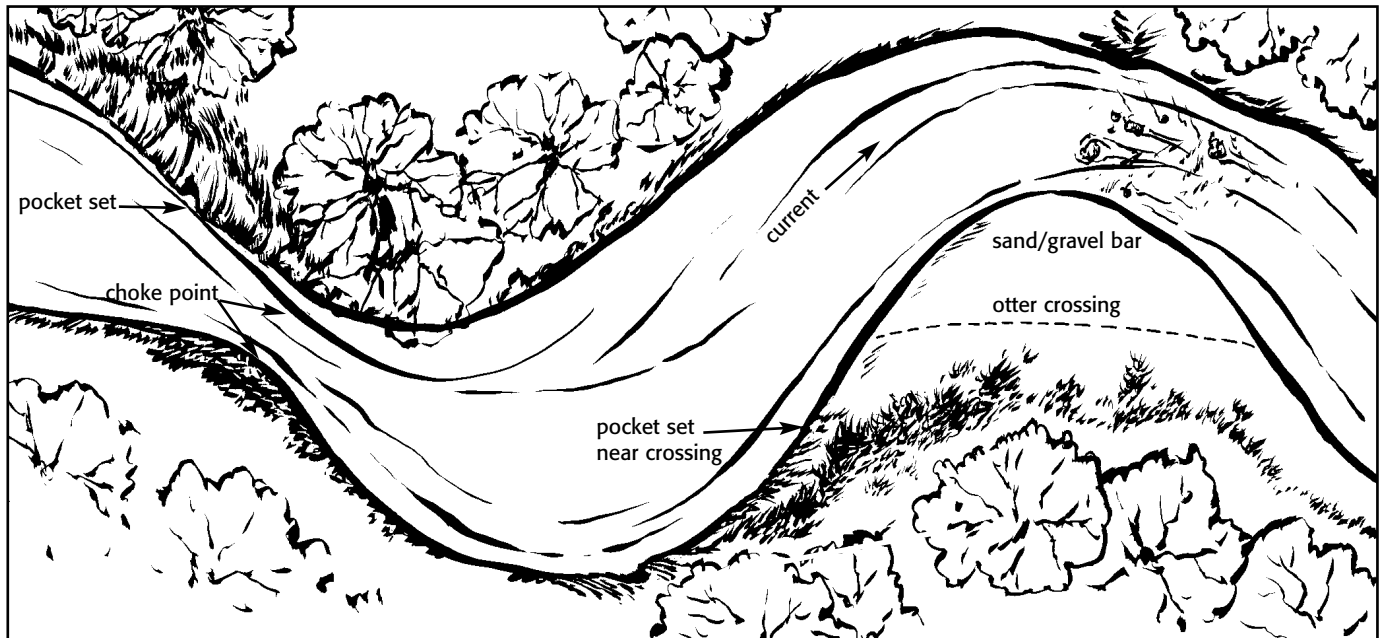

*Pocket sets are used when the sets mentioned in the previous pages will not work. Look for a location where a deep channel or overland otter trail is next to a steep bank.*

### **Pocket sets**

Channel sets, crossover sets, latrine site sets and sets at beaver dens and lodges are the most effective for otters. However, on rare occasions when no suitable locations for any of these sets exist, a pocket set can be used.

Because otters are nearsighted, the location of the pocket set is crucial. If the set is not located within a few feet of where otters travel, they may not notice it at all. Look for a location where a deep channel or overland otter trail is next to a steep bank.

To construct a pocket set, dig a hole into the bank to resemble a small beaver den entrance. The best place is in a firm, fairly steep bank

free of rocks or tree roots. Use either a #330 body-grip or a foot-hold trap. Pocket sets with foot-hold traps will likely catch non-target furbearers such as raccoons and mink. They should be used when other options won't work, or during the regular furbearer trapping season when the other pelts can be marketed.

For a #330 body-grip set, excavate a trench into the bank leading to the hole that is large and deep enough so the trap can be placed just outside the hole and underwater. Then dig a 10-inch hole 3 feet into the bank at an upward angle. The upper end of the hole should be above the water. Place the trap just outside the hole, and use two dry sticks to hold it firmly

as described in the channel sets section on page 15. Place a large piece of fish at the back of the hole for bait. For additional eye appeal, put a chicken egg in the hole.

To use a foot-hold trap, such as a #1 1/2 coil spring or #11 long spring, begin by digging a hole upward and angled back into the bank 2 inches above water level. Use your hands to smooth the den-like hole, bait it with fish and add an egg.

Excavate a flat area in the bottom lip of the hole so the water runs back into the hole 5 or 6 inches. Then firmly set the trap on the flat area in front of the hole under about 2 inches of water. Attach the trap to a drowning set as shown on page 12.

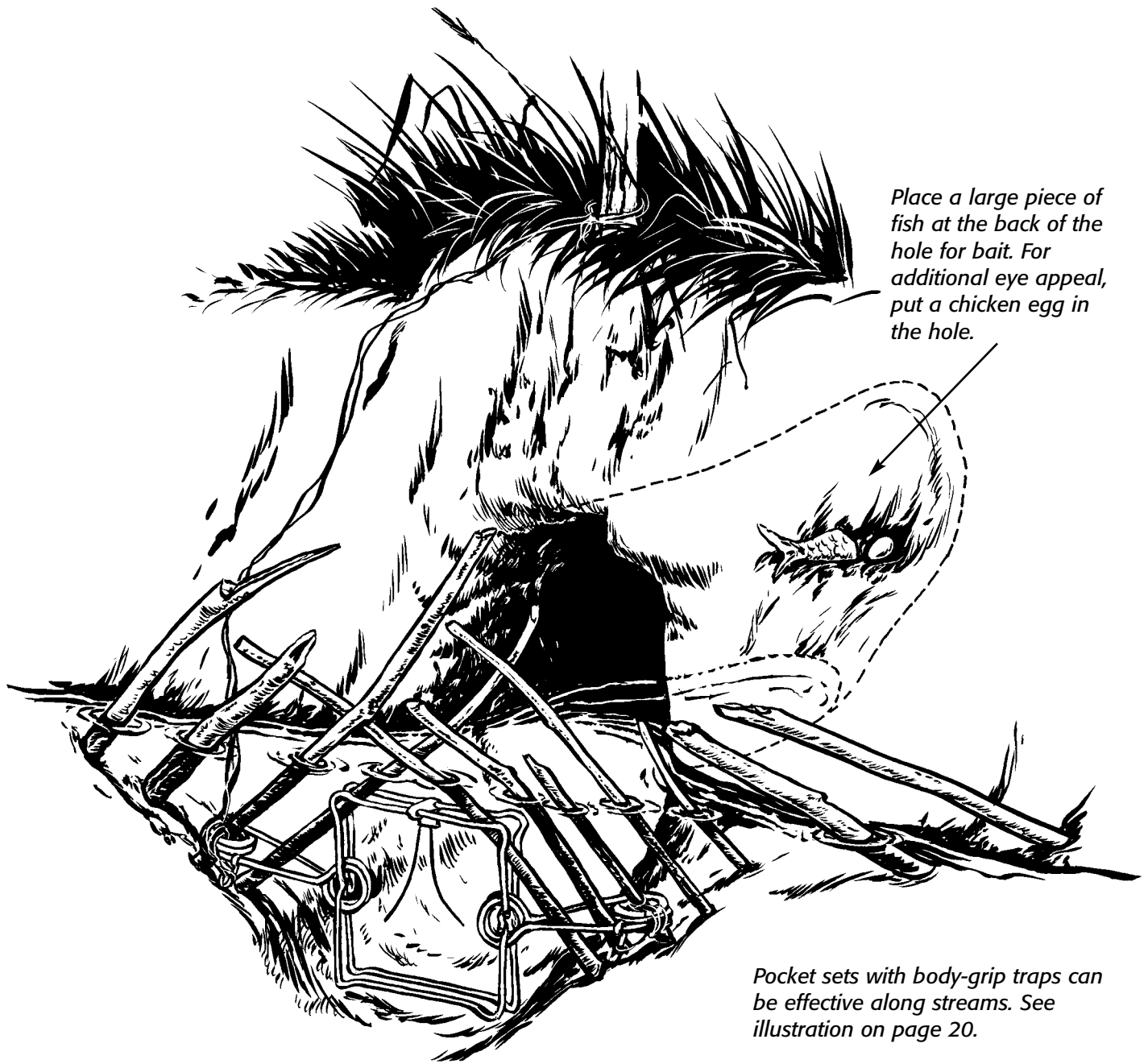

*Place a large piece of fish at the back of the hole for bait. For additional eye appeal, put a chicken egg in the hole.*

*Pocket sets with body-grip traps can be effective along streams. See illustration on page 20.*

## Marketing Pelts

While pelt prices for most furbearers fluctuate over time, otter pelts generally hold their value. Otters trapped during the regulated trapping season by a licensed trapper can legally be sold after being tagged by a conservation agent. Tagging may be performed after the otter is skinned or after the pelt has been dried. Otter pelts must be tagged and sold within 15 days after the end of the trapping season.

Several fur buyers and dealers throughout the state buy otter and other furbearer pelts. Contact your local conservation agent to locate a buyer in your area. The Missouri Trapper's Association sponsors two or three fur auctions in the state each year. Some trappers find it profitable to ship their fur to Canadian auctions.

### Fur preparation

To make best use of an otter skin, the animal and pelt need to be handled properly from the time it is caught until it is sold. Proper handling begins when the otter is removed from the trap.

The animal should be washed at the trap site to remove any sand or mud and kept clean while transported. If the fur is still wet when you get home, rub it down with a soft cloth or paper towels to remove most of the water, then hang it in a warm place in front of a fan until it dries.

Otter are difficult to skin because most of the skin must be cut free of the flesh. Having proper equipment makes handling the fur easier and more efficient. A pocket

knife with a 3-inch long, slender blade—often called a muskrat blade—is a good choice because it helps you make clean opening cuts in the skin. Use a good quality sharpening stone and butcher's steel to keep the blade sharp.

Be careful when skinning, especially around the front legs. Fur buyers pay less for pelts with holes in them.

Fleshing otter pelts is difficult. Unless the person is experienced with a fleshing knife, the pelts should be frozen after skinning and sold green, without fleshing and drying. Thaw the skins just before taking them to a dealer. If you are experienced and want more money for your pelts, flesh, stretch and dry the skin before selling it.

### How to skin an otter

1. Hang the otter by one or both of the hind feet.
2. Cut around each hind leg just below the feet.
3. Make the opening cuts down the inside of each hind leg to just above the anus.
4. The two cuts should join just above the anus.

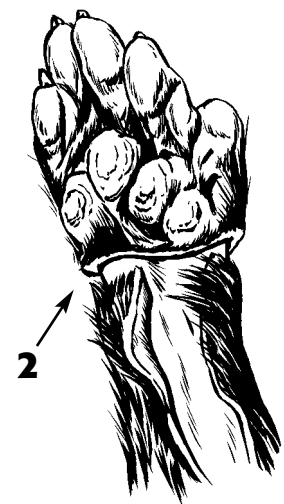
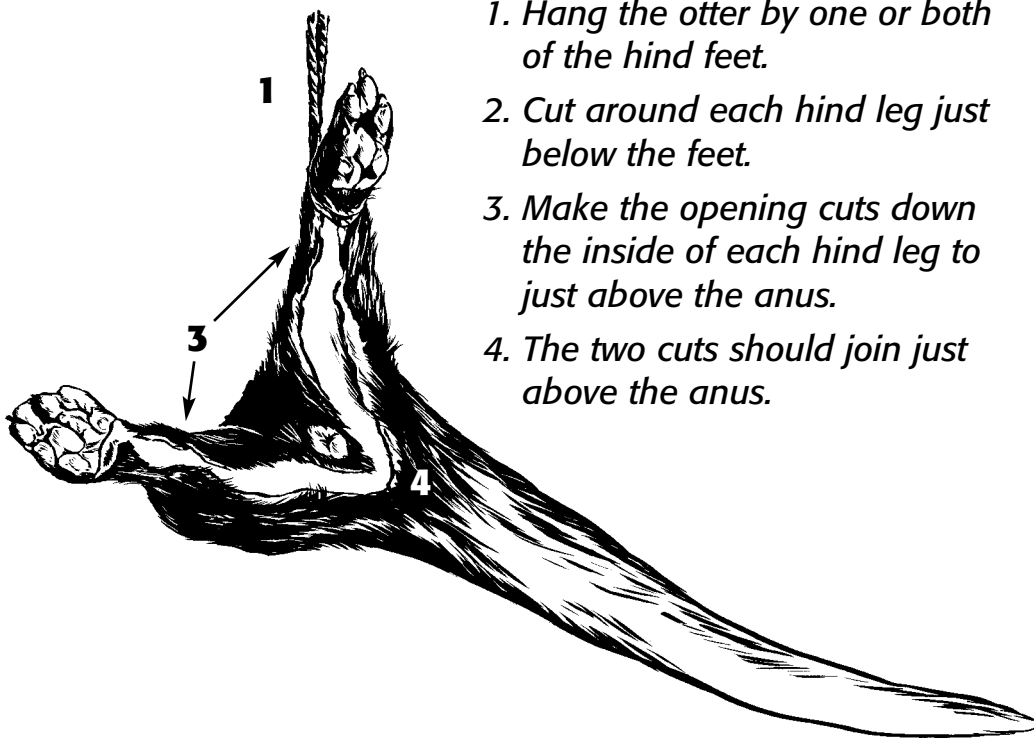



5. Cut the center of the underside of the tail from the anus all the way to the tip.

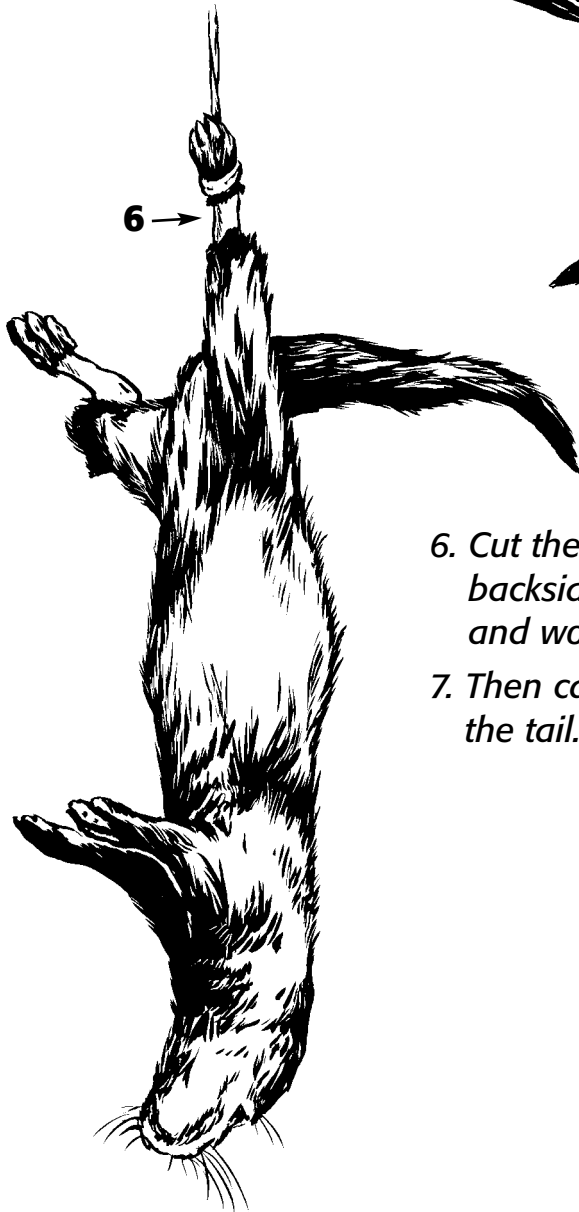
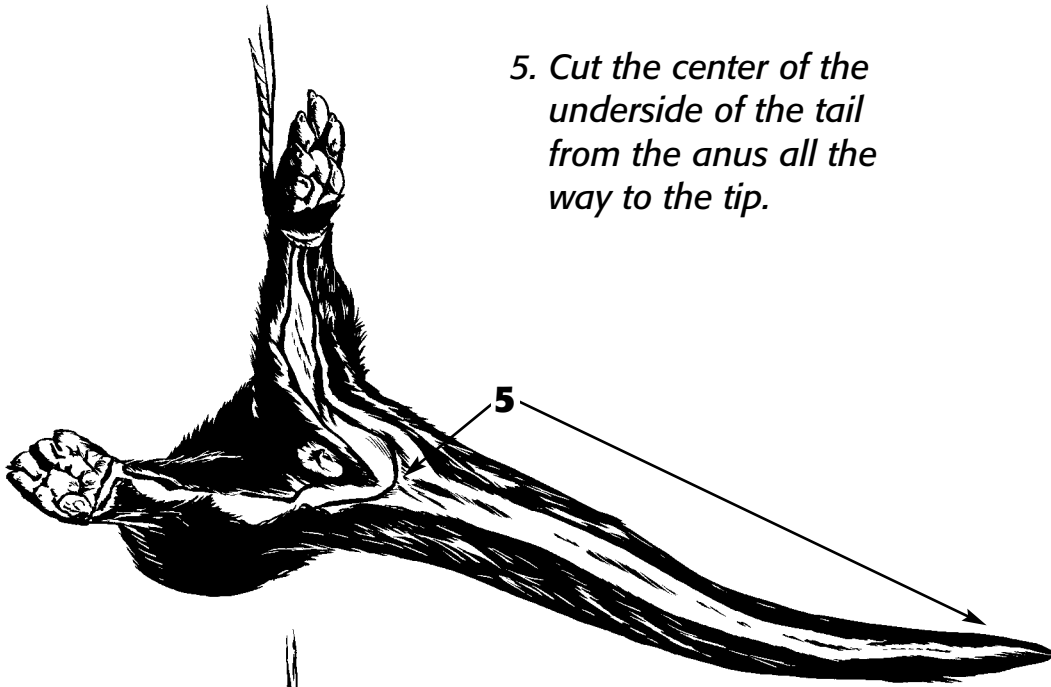

6. Cut the skin from the backside of the hind legs and work the tail loose.

7. Then carefully skin out the tail.

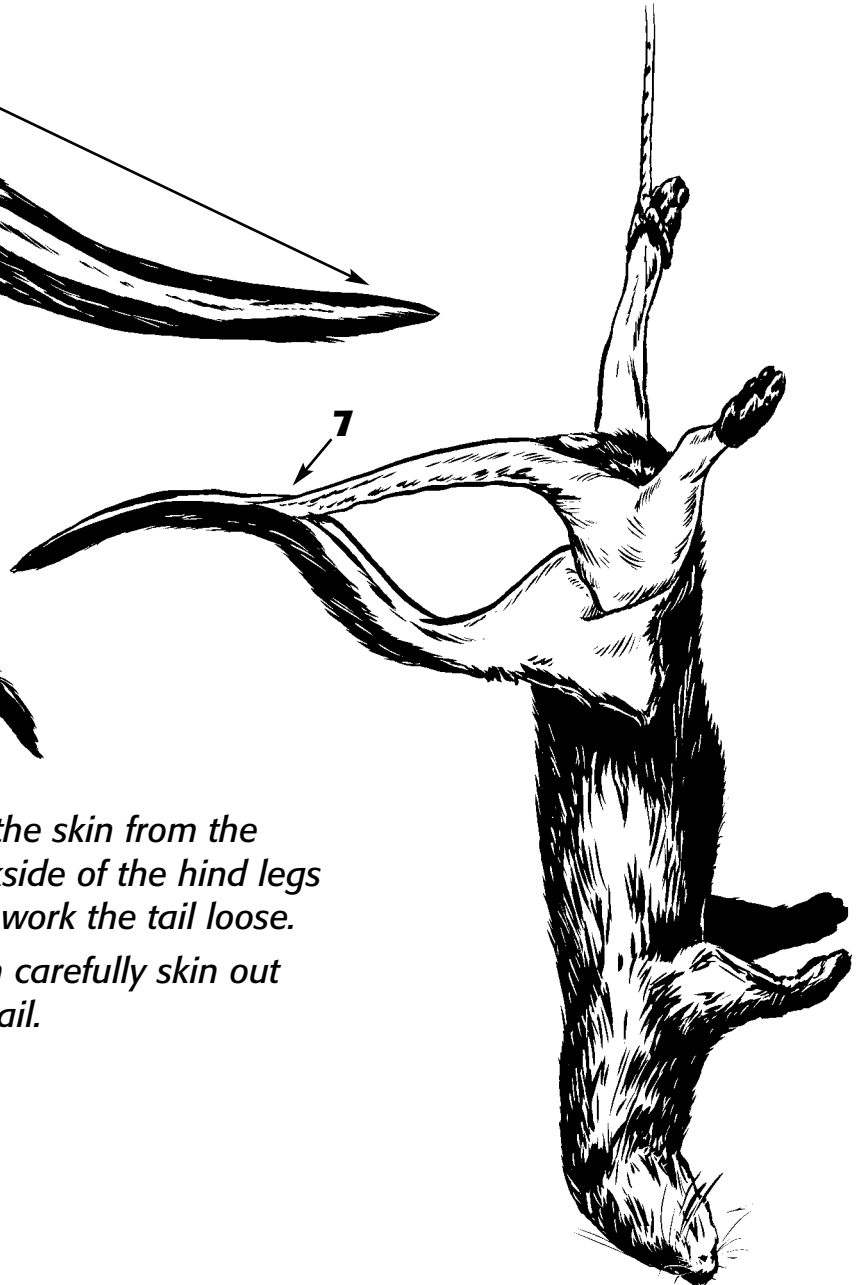

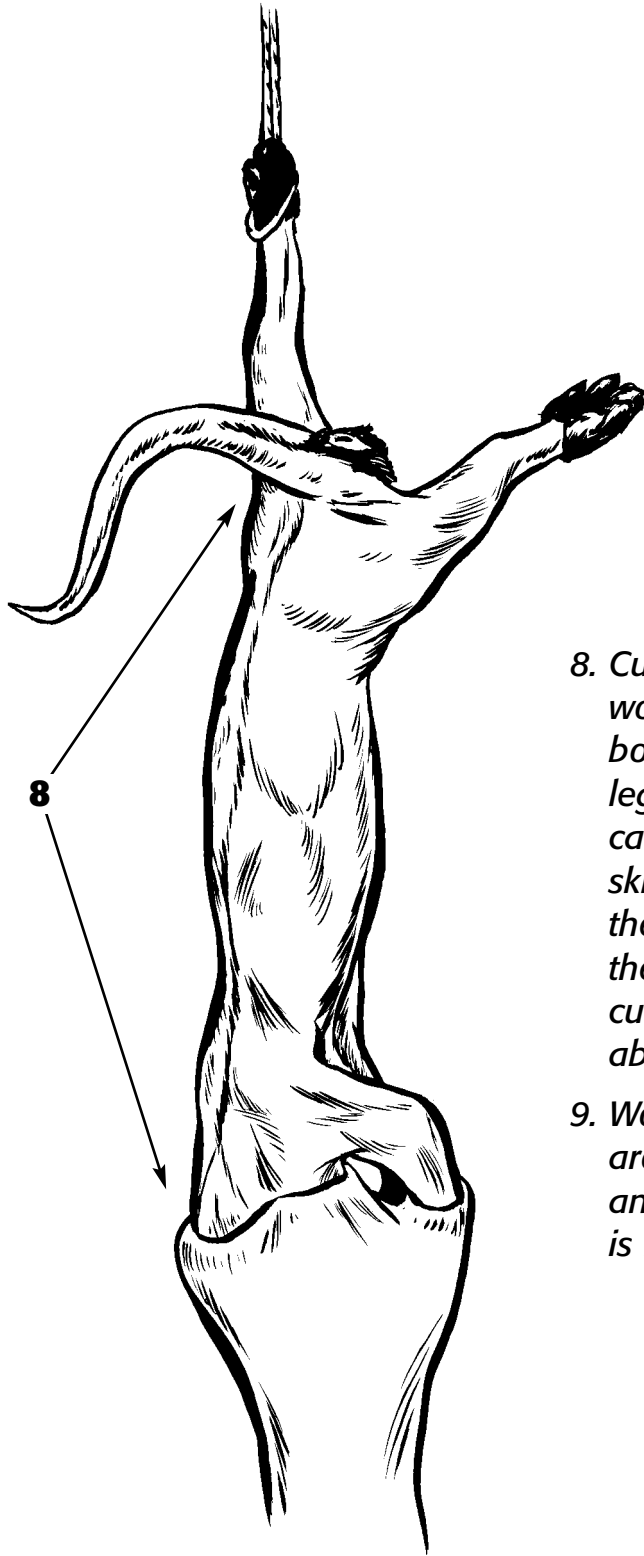

8. Cut the skin free and work it down the body to the front legs. Be especially careful not to cut the skin while working the legs free. After the legs are skinned, cut the skin just above the front feet.

9. Work carefully around the ears, eyes and lips until the pelt is free.

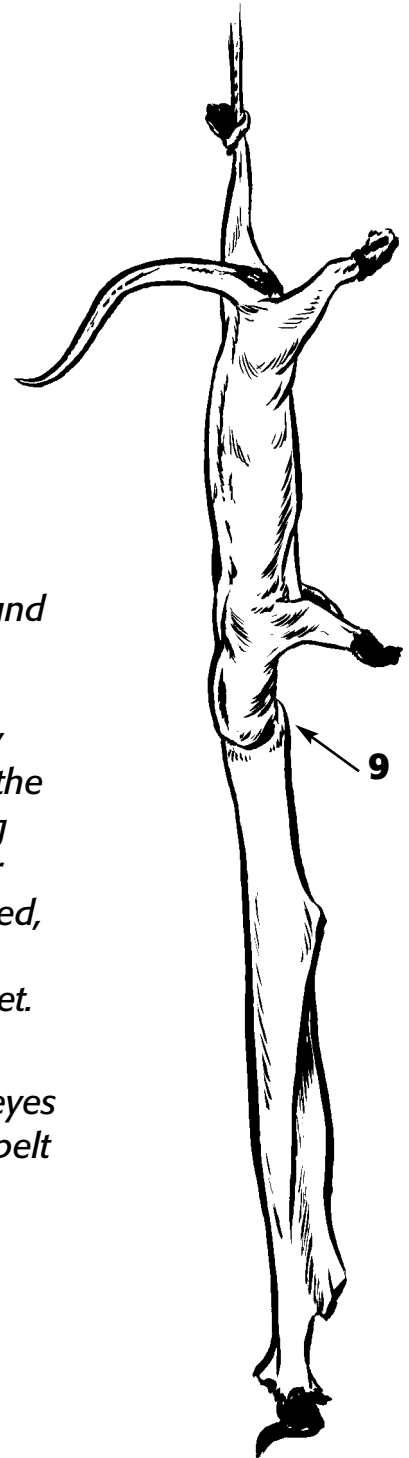

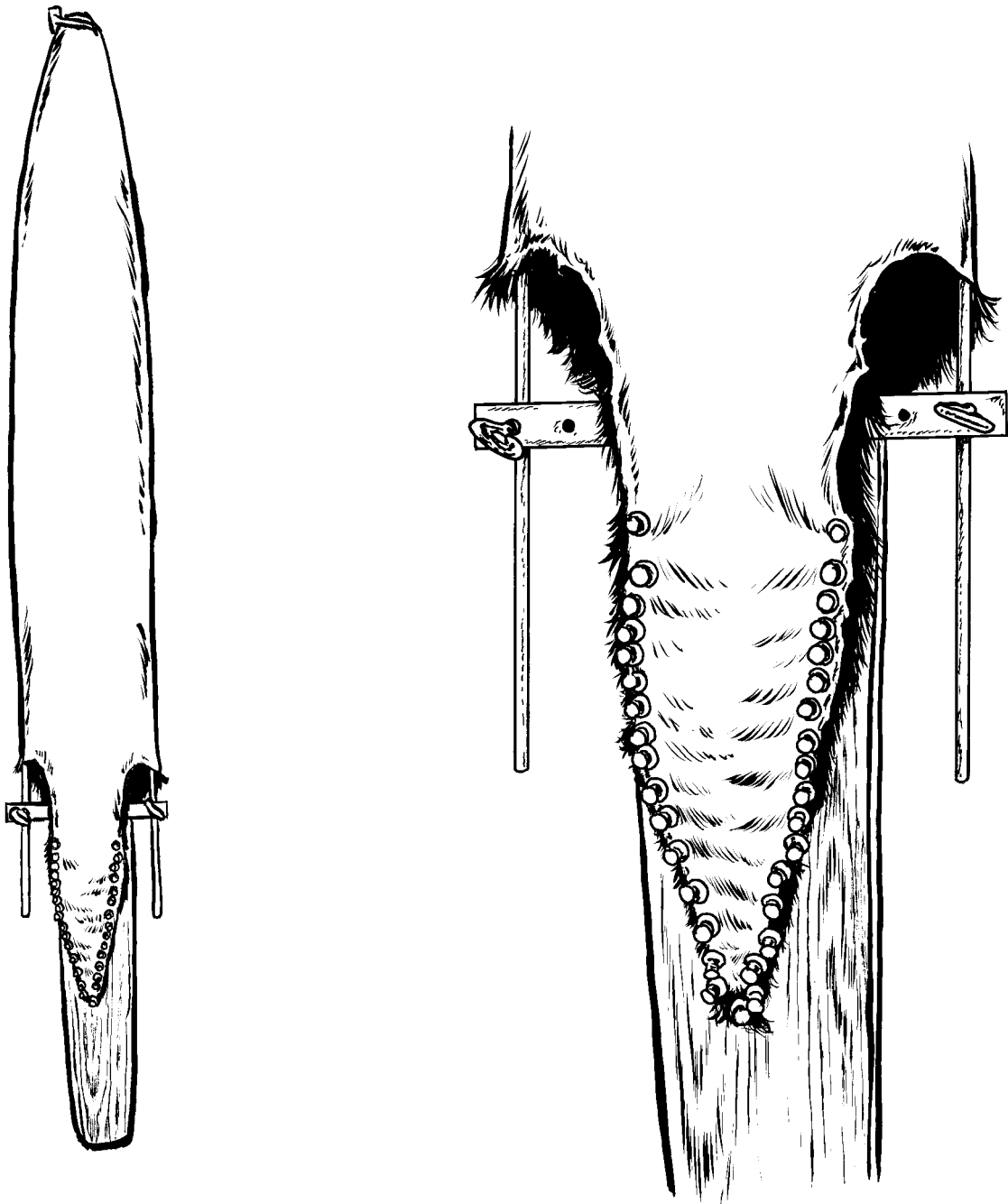

*To sell the skin green, roll it up, place it in a plastic bag to help prevent freezer burn and freeze it. To dry the skin, stretch it on a board, place tacks around the tail. Leave on the board until the skin is completely dry.*

# Missouri Department of Conservation Regional Offices

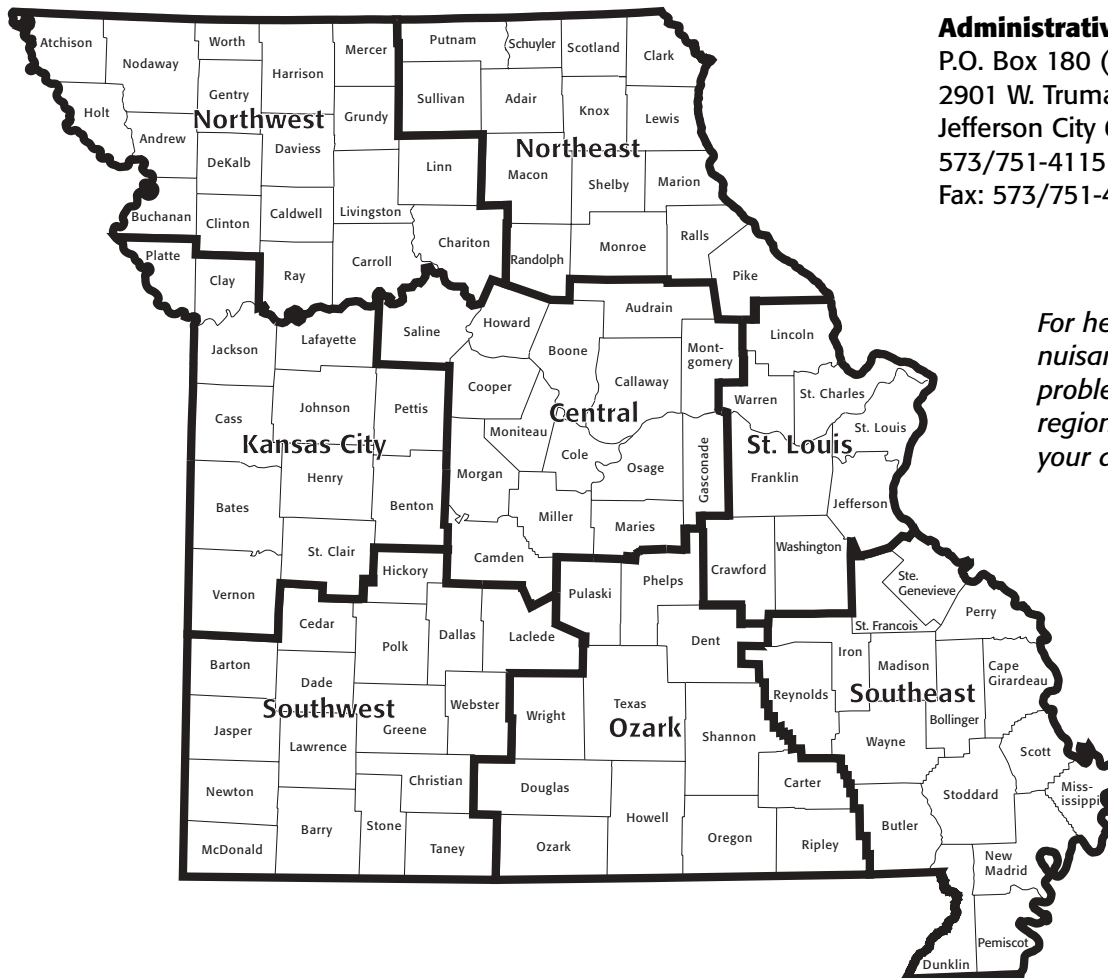

**Administrative Office**  
 P.O. Box 180 (zip 65102)  
 2901 W. Truman Blvd.  
 Jefferson City 65109  
 573/751-4115  
 Fax: 573/751-4467

*For help with  
 nuisance wildlife  
 problems, call the  
 regional office in  
 your area.*

**Northwest**

701 N.E. College Drive  
 St. Joseph 64507  
 816/271-3100  
 Fax: 816/271-3107

**Northeast**

2500 S. Halliburton  
 Kirksville 63501  
 660/785-2420  
 Fax: 660/785-2553

**Kansas City**

3424 N.W. Duncan Road  
 Blue Springs 64015  
 816/655-6250  
 Fax: 816/655-6256

**Central**

1907 Hillcrest Drive  
 Columbia 65201  
 573/884-6861  
 Fax: 573/882-9807

**St. Louis**

2360 Highway D  
 St. Charles 63304  
 636/441-4554  
 Fax: 636/926-9125

**Southwest**

2630 N. Mayfair  
 Springfield 65803  
 417/895-6880  
 Fax: 417/895-6910

**Ozark**

551 Joe Jones Blvd.  
 P.O. Box 138  
 West Plains 65775  
 417/256-7161  
 Fax: 417/256-0429

**Southeast**

2302 County Park Dr.  
 Cape Girardeau 63701  
 573/290-5730  
 Fax: 573/290-5736

**Web address: [www.conservation.state.mo.us](http://www.conservation.state.mo.us)**









PLS052  
12/2002